

P. FOLEGA* G. SIWIEC**

NUMERICAL ANALYSIS OF SELECTED MATERIALS FOR FLEXSPINES**ANALIZA NUMERYCZNA WYBRANYCH MATERIAŁÓW KÓŁ PODATNYCH**

The computer analysis of the influence of flexspline materials at the strength of the flexspline was performed for two and three dimensional models using the finite element method and MSC Patran/Nastran software. Calculations were conducted in two steps. The first one concerns two dimensional models on the contact between the flexspline and the wave generator. The second concerns three dimensional models of flexspline. The application of steel and steel-composite materials as material of the flexspline in harmonic drive was analysed. In calculations were used two types of composites with an epoxy resin, reinforced by the carbon-fiber or the glass-fiber. The preliminary study of stresses for the developed models was made. The steel-composite hybrid flexspline as compared to conventional steel flexspline showed a decrease of maximum stress in the analyzed dangerous cross-sections. Shapes and the frequency of vibration of the flexsplines were also calculated. The impact of stacking fiber angle on the frequency of vibration in the tested flexsplines is negligible.

Keywords: materials, flexspline, harmonic drive, finite element method

Przeprowadzono analizę komputerową wpływu materiałów kół podatnych na ich wytrzymałość przy pomocy dwu i trójwymiarowych modeli wykorzystując metodę elementów skończonych oraz oprogramowanie MSC Patran/Nastran. Obliczenia przeprowadzono w dwóch etapach. Pierwszy z nich dotyczył dwuwymiarowych modeli kontaktu koła podatnego i generatora fali. Drugi dotyczył trójwymiarowych modeli kół podatnych. Przeprowadzono analizę zastosowania stalowych oraz stalowo-kompozytowych materiałów na koła podatne przekładni falowej. W obliczeniach wykorzystano dwa rodzaje kompozytów z osnową z żywicy epoksydowej, zbrojonej włóknem węglowym lub włóknem szklanym. Dla opracowanych modeli została wykonana wstępna analiza stanu naprężenia. Analizując otrzymane wyniki obliczeń symulacyjnych przyjętych rozwiązań konstrukcyjnych kół podatnych stwierdzono zmniejszenie wartości naprężeń w rozpatrywanych przekrojach stalowo-kompozytowych kół podatnych w porównaniu z tradycyjnymi kołami stalowymi. Wyznaczono ponadto postacie i częstotliwości drgań badanych kół podatnych. Stwierdzono że, wpływ kąta ułożenia włókien na częstotliwości drgań badanych kół podatnych jest nieznaczny.

1. Introduction

A harmonic drive (Fig. 1) consists of a toothed mechanism, which composed of three main elements: a rigid circular spline, an elliptical wave generator and a flexible spline, which is called the flexspline. The flexspline it is the main component of a harmonic drive, which can generate a repeated vibration by the wave generator. With this a reason, the flexspline should have flexibility and good vibration characteristics [2-4].

The wave generator deflects the elastically deformable flexspline elliptically across the major axis.

Due to that, the teeth of the flexspline engage simultaneously with the ring gears of circular spline in two zones at either end of the major elliptical axis. Across the minor axis of the elliptically deflected flexspline there is no engagement. When the wave generator rotates, the meshing zones of the flexspline rotate with the generator. A difference in the number of teeth between the flexspline and the circular spline the latter has two teeth more results in a relative movement between these gear wheels. After a complete rotation of the wave generator, the flexspline moves relative to the circular spline by an angle equivalent to two teeth.

* SILESIAAN UNIVERSITY OF TECHNOLOGY, FACULTY OF TRANSPORT, 40-019 KATOWICE, 8 KRASIŃSKIEGO STR., POLAND

** SILESIAAN UNIVERSITY OF TECHNOLOGY, DEPARTMENT OF METALLURGY, 40-019 KATOWICE, 8 KRASIŃSKIEGO STR., POLAND

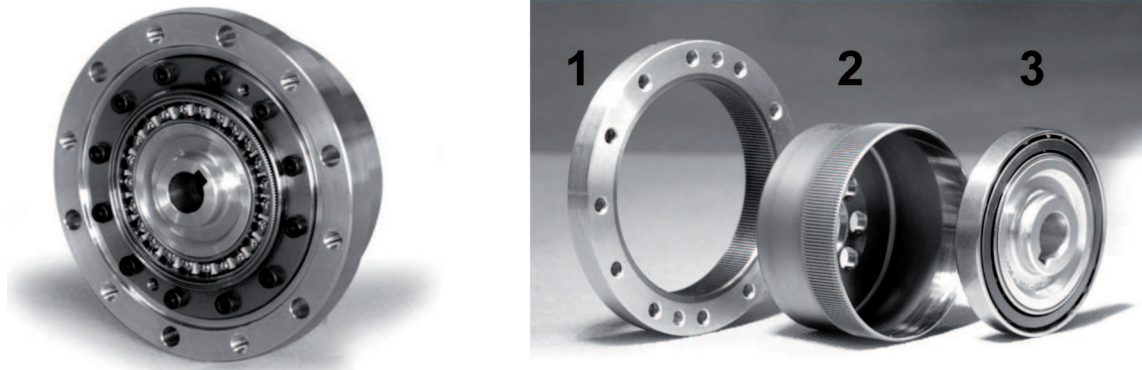

Fig. 1. Main elements of the harmonic drive [1]: 1 – circular spline, 2 – the cup-type of flexspline, 3 – wave generator

Compared to classical toothed gears, harmonic drives have numerous advantages, but there are some disadvantages as well. Their main advantages include: high torque capacity, excellent positioning accuracy and repeatability, compact design, zero backlash, high single-stage reduction ratios and high torsion stiffness. On the other hand, their drawbacks are: high elasticity and nonlinear stiffness and damping. The application of toothed harmonic drives in various fields of life is more and more wide. They are currently used in the automotive and space industries, in aviation, medicine, automatics and robotics.

When designing the flexspline, it is very important to determine and choose properly its geometrical features. Adequate selection of dimensions of the flexspline should ensure minimization of stresses in dangerous cross-sections and a more constant stress distribution along the flexspline, which must be flexible in the radial direction but must be stiff in the torsion direction. These phenomena cannot be avoided when the flexspline is made of conventional isotropic materials such as steel [1]. Therefore significant enhancement of the harmonic drive is possible through a rational selection of geometrical parameters of the flexspline, but also through applying suitable materials or technological treatments. Using composites on the flexspline enables weight reduction of the flexspline and increases significantly its radial susceptibility and damping of vibration [2, 5-6]. The production of flexsplines made entirely from composites is, however, constrained by technological difficulties connected with creating their toothed ring gear. This problem may be solved by the application of so-called „complex” steel-composite hybrid flexsplines [7]. An advantage of this solution is the possibility of producing a steel flexspline with toothed ring gear, where a composite is applied onto the internal surface of a steel flexspline (most often, throughout the width of the toothed ring gear – Fig. 2). That may significantly improve its mechanical properties in this area, because the composite

material has a high specific strength, a high stiffness and a high damping capacity [2, 5]. An example of such solution and a description of the technological process of producing such flexspline are presented in work [3].

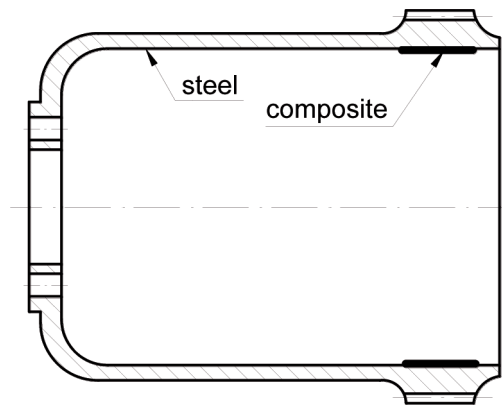

Fig. 2. Construction of a steel-composite cup-type flexspline

2. Numerical models of flexsplines

Creating parametric models of flexspline we must specify boundary conditions. This involves the problem of determining the load distribution in toothed ring gear of the flexspline and in contact zone the wave generator with the flexspline, depending on the torque. In his experiments Ivanov [8] observed that under the loading the flexspline tends to detach itself from the wave generator in two regions at some angle after the major deformation axis due to circumferential buckling under the loading. The approximate loading conditions of the flexspline and the analytical procedure for determination of the stress-deformation state of the flexspline is based on the modified theory of shells, described by Ivanov [8]. The analytical procedures assume that under the loading different regions of the flexspline deform in the shape of known geometrically curves, which are mathematically easy to describe. Such simplification gives raise

to a discontinuous stress field along the circumference of the flexspline and overestimation of the peak stress value used for the design of flexspline thickness. Therefore a numerical analysis of the flexspline becomes a necessity for optimum design. Recently few researchers have successfully used the FEM to analyze the flexspline. Suvalov and Gorelov [9-10] conducted series of 2D FEM calculations of the flexspline cross-section in the region of two loaded teeth. Toropcjin [11] chose the axial cross-section for its 2D FEM calculations aiming at the optimum design of the flexspline, which is fixed on one end to the housing. However, this analysis failed to address the problem, because the flexspline is the buckling by the torque [4, 9-12]. Kayabasi and Erzincanli [12] studied the stresses on flexspline teeth and find optimum shape of teeth to maximize fatigue life.

In this paper, the authors proposed a numerical analysis of the flexspline divided into two stages. The first most important step involves a nonlinear finite element analysis of the contact between the flexspline and the wave generator [13-14]. The radial cross-section of the flexspline is analyzed in respect to the maximum displacements caused by the wave generator. Since the loading of the flexspline is not symmetrical the whole flexspline is divided into elements (Fig. 3).

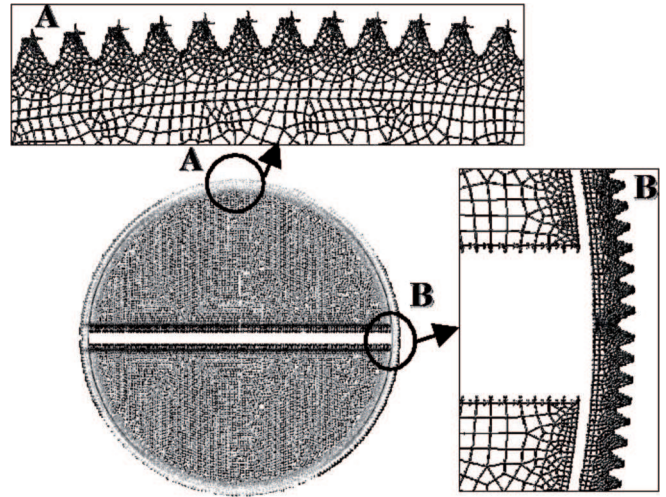

Fig. 3. The two-dimensional FEM model

The wave generator construction used in the model is opposite positioned discs. The contact between the flexspline and each of the discs is along the angle $\pm 30^\circ$ measured from the major symmetrical axis. The wave generators discs were modeled with a single line of finite elements along the discs boundaries in range $\pm 90^\circ$ from the major symmetrical axis. Inner nodes of the flexspline mesh and the outer nodes of the discs meshes were in contact along the angle $\pm 30^\circ$, measured from the major

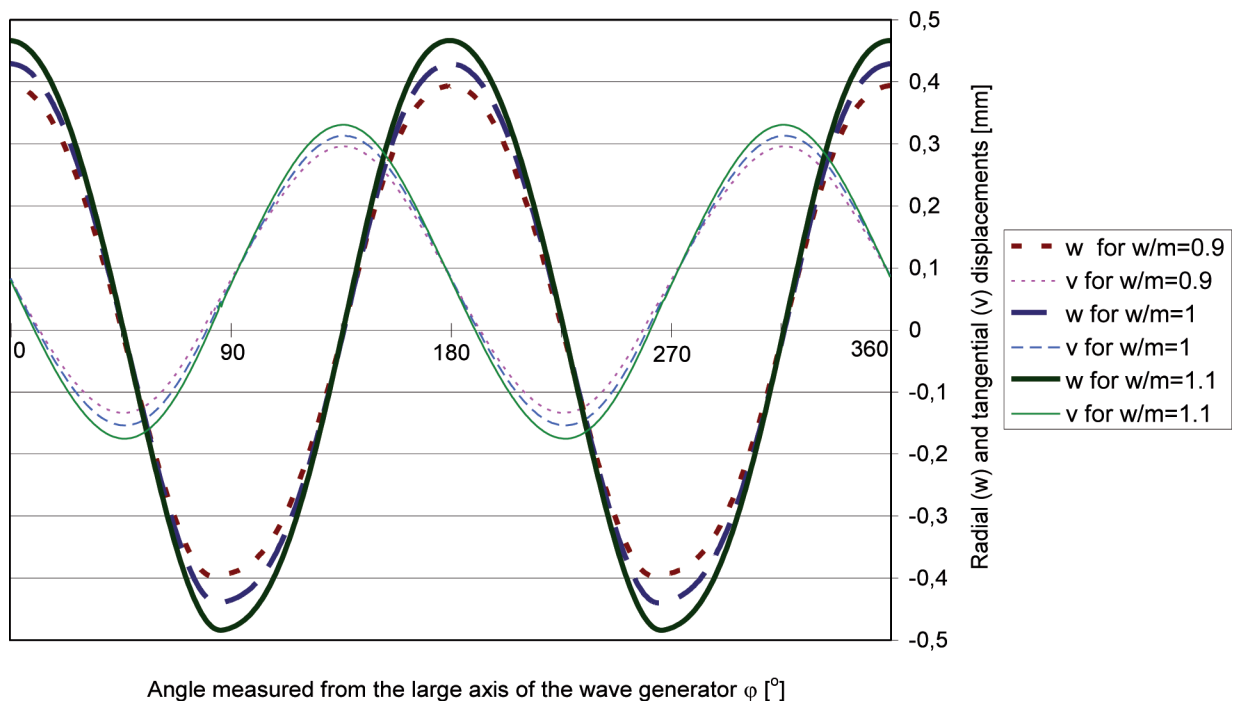

Fig. 4. Chart of radial (w) and tangential (v) displacements as a function of angle measured from the large axis of the wave generator

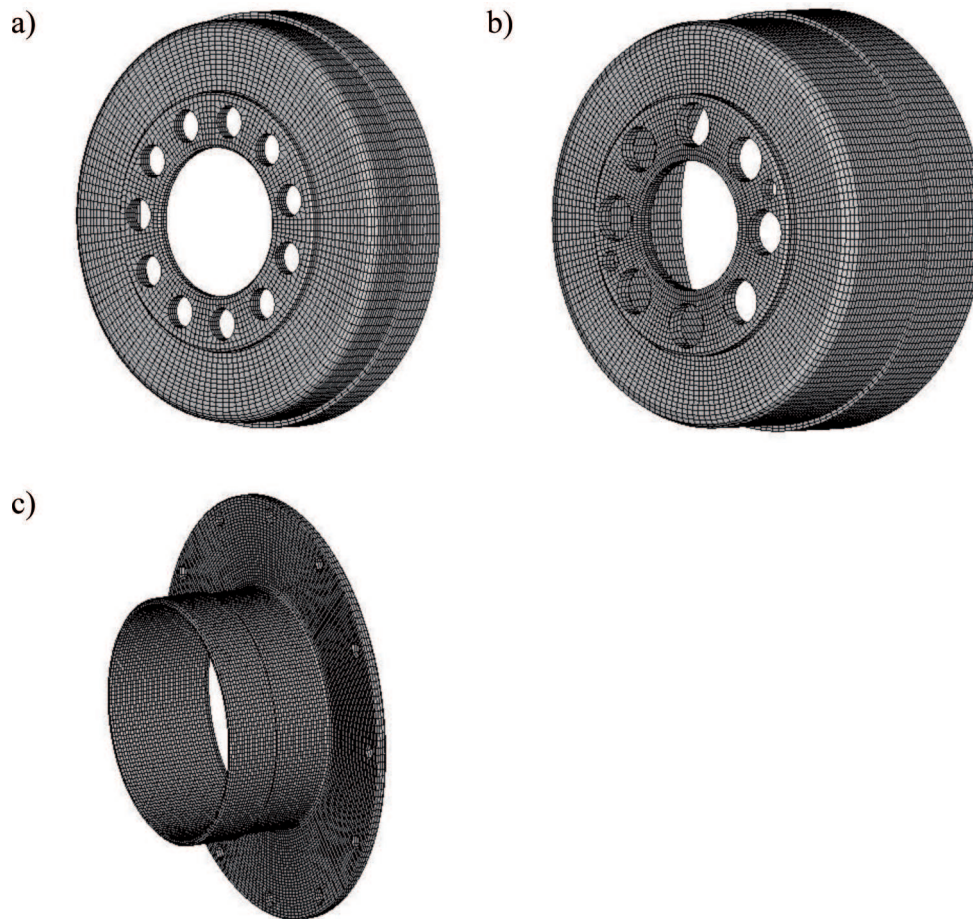

Fig. 5. The three-dimensional FEM models of flexsplines: a) a short cup-type, b) a cup-type, c) with an outer flange

symmetrical axis. The nodes on the potentially contacting surfaces of the flexspline and of the wave generator discs were connected with gap elements. MSC Patran/Nastran was used in calculations with FEM. The calculated radial (w) and tangential (v) displacements (Fig. 4) from the above nonlinear contact analysis were used in three-dimensional numerical models of the flexsplines. The values shown in figure 4 correspond qualitatively and quantitatively to the results presented in the literature [12].

In a single-stage harmonic drive, the flexspline may be either a stationary or a moving part. In the first case, it is connected directly or through a toothed clutch to the gearbox housing, whereas in the second case, it is connected directly or through a clutch to an output shaft. Nowadays, steel flexsplines in harmonic drives are most often manufactured as [1]: a short cup-type (Fig. 5a), a cup-type (Fig. 5b) or with an outer flange (Fig. 5c).

In the analysis of the three-dimensional numerical models, assumptions were adopted similar as in the work [13]. The flexspline is thin-shell axial-symmetric loaded in a static manner. In these models does not include of teeth. The teeth of toothed ring gear were replaced by

the local increase in wall thickness of a flexspline. In these models, the load displacement values determined in two-dimensional model were assumed. The developed three-dimensional FEM models of flexsplines were shown in Fig. 5.

3. Calculation results

The numerical analysis was performed using developed models of flexspline for: steel and steel-composite, assuming the two types of composites with an epoxy resin reinforced by the glass-fiber or the carbon-fiber. In Tables 1 and 2 were shown properties for steel and composite materials used in calculations.

TABLE 1

Properties of the steel 42CrMo4

Tensile modulus (GPa)	210
Shear modulus (GPa)	80
Poisson's ratio	0,3
Tensile strength (MPa)	1000
Density (kg/m^3)	7850

TABLE 2

Properties of the composite materials		
Properties of the epoxy resin		
Tensile modulus (GPa)	1,3	
Shear modulus (GPa)	0,45	
Poisson's ratio	0,40	
Tensile strength (MPa)	45	
Shear strength (MPa)	29,5	
Density (kg/m ³)	1200	
Properties of the fiber		
	Glass fiber	Carbon fiber
E_L (GPa)	43,5	130
E_T (GPa)	5,0	8,0
G_{LT} (GPa)	5,0	6,0
ν_{LT}	0,25	0,28
Density (kg/m ³)	2050	1710

The geometrical dimensions of flexsplines adopted for the calculation were shown in Figure 6 and Table 3. In calculations thickness of the composite of $g_K = 0,6$ mm on width $b_w = 25$ mm were assumed. Composite materials used in calculations were analyzed for different values of the stacking fiber angle θ (fiber orientation) in the outer and inner layer, in values to, respectively, $\pm 15^\circ$, $\pm 30^\circ$, $\pm 45^\circ$, $\pm 60^\circ$, and $\pm 75^\circ$.

TABLE 3

The geometrical dimensions of flexsplines	
L [mm]	51
d_w [mm]	107
d_d [mm] (a cup type of flexspline)	25
d_d [mm] (a flexspline with outer flange)	140
b_w [mm]	25
g_k [mm]	0,6

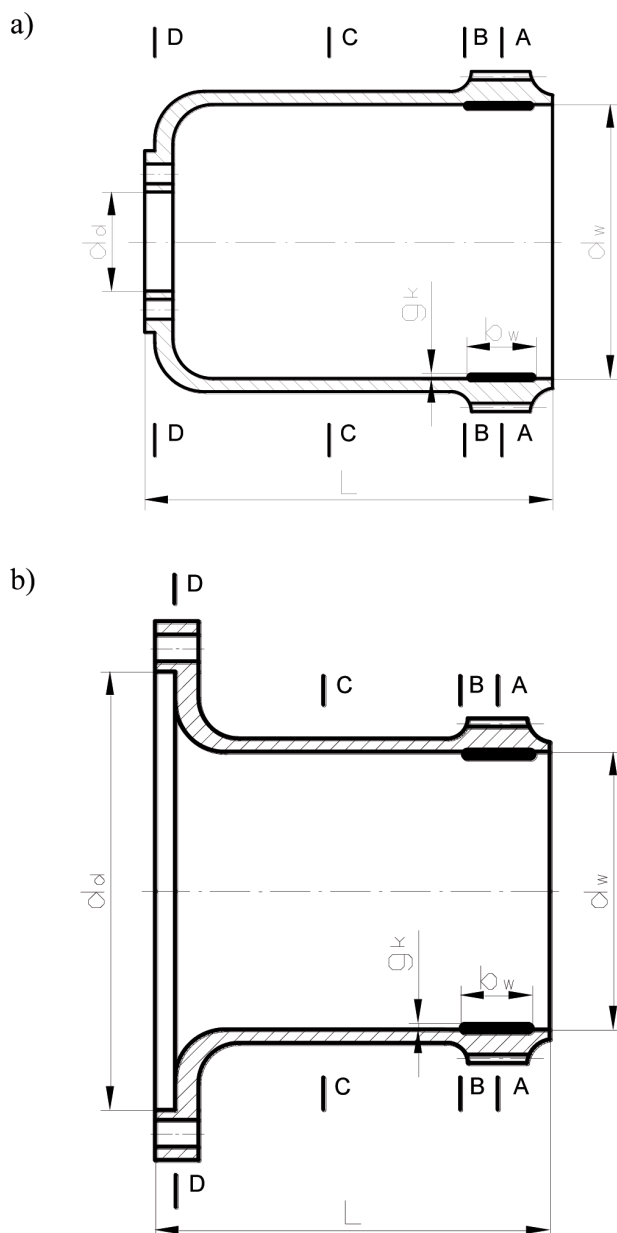

Fig. 6. The geometrical dimensions of flexsplines: a) a cup-type, b) with an outer flange

The analysis of the stress state was performed for the following cross-sections of the investigated flexsplines (Fig. 6): in the middle of the width of the toothed ring gear (A-A), on the boundary of transition of the toothed ring gear into a smooth part of the flexspline (B-B), in the middle of the flexspline length (C-C) and in the back part of the flexspline (D-D). Dangerous sections exposed to a considerable increase of stress values are located on the boundary of transition of the toothed ring gear into a smooth and in the back part of the flexspline (sections B-B and D-D, respectively).

Examples of the results of calculations conducted on the prepared numerical models of the steel and steel-composite hybrid flexsplines are presented in Figs. 7 to 10. The calculations have shown a decrease in the maximum stress in the studied sections in the steel-composite hybrid flexsplines in comparison to the traditional steel flexspline (Fig. 7). Figure 8 shows the results concerning the impact of the stacking fiber angle on the stresses in cross-section (B-B). For steel-composite hybrid flexsplines with an epoxy resin reinforced by the carbon-fiber, a reduction of stress was found in comparison to steel flexspline for stacking fiber angle $\theta = \pm 75^\circ$ (up to 9%). For steel-composite hybrid flexsplines with an epoxy resin reinforced by the glass-fiber the reduction of stress is observed at the level of 2% in relation to the steel flexsplines.

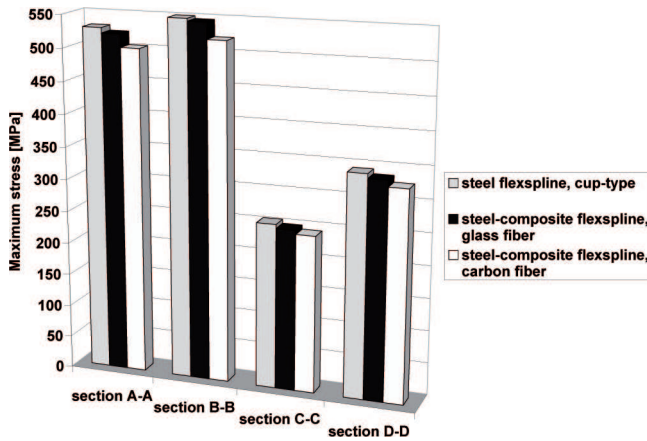

Fig. 7. Maximum stress in the studied sections of a cup-type flexspline

For the studied numerical models of flexsplines, the shapes and values of vibration frequency were also determined. Fig. 9 shows some examples of the shapes of vibration for the steel flexspline. Fig. 10 shows the values of the first frequency for the analysed flexsplines depending on the stacking fiber angle. When analyzing the results of calculations shown in Fig. 10 it could be seen that the impact of stacking fiber angle for the tested flexsplines on the frequency of vibration is negligible. Using the steel-composite hybrid flexsplines made with an epoxy resin reinforced by the carbon-fiber resulted in more than 2.0 fold increase in the value of the first natural frequencies compared with the steel flexsplines, whose first vibration frequency was 750 Hz in a cup-type and 610 Hz with an outer flange.

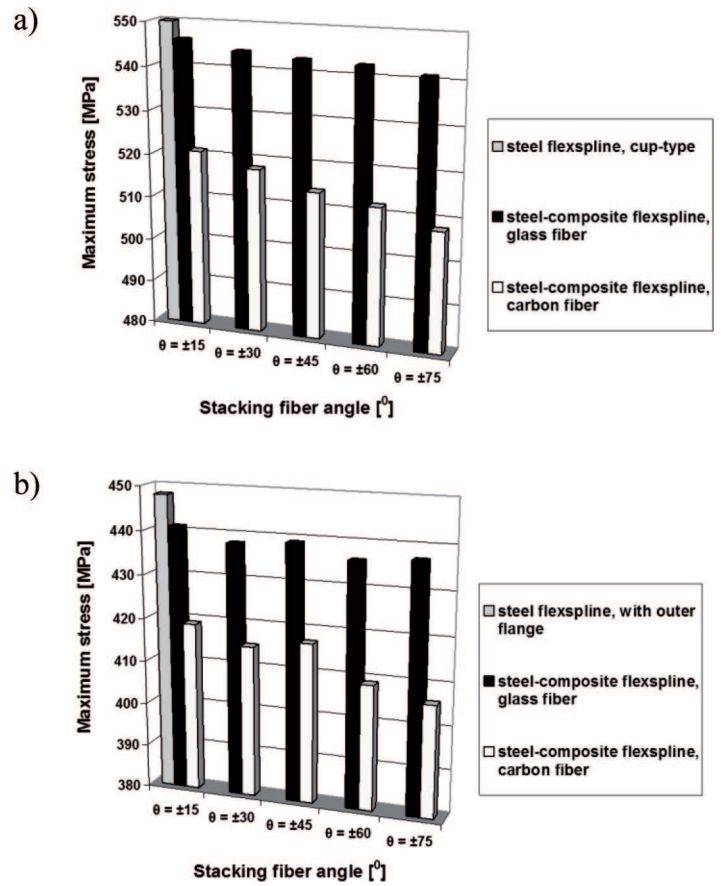

Fig. 8. Stresses of analyzed flexsplines in section (B-B) depending on stacking fiber angle: a) a cup-type, b) with an outer flange

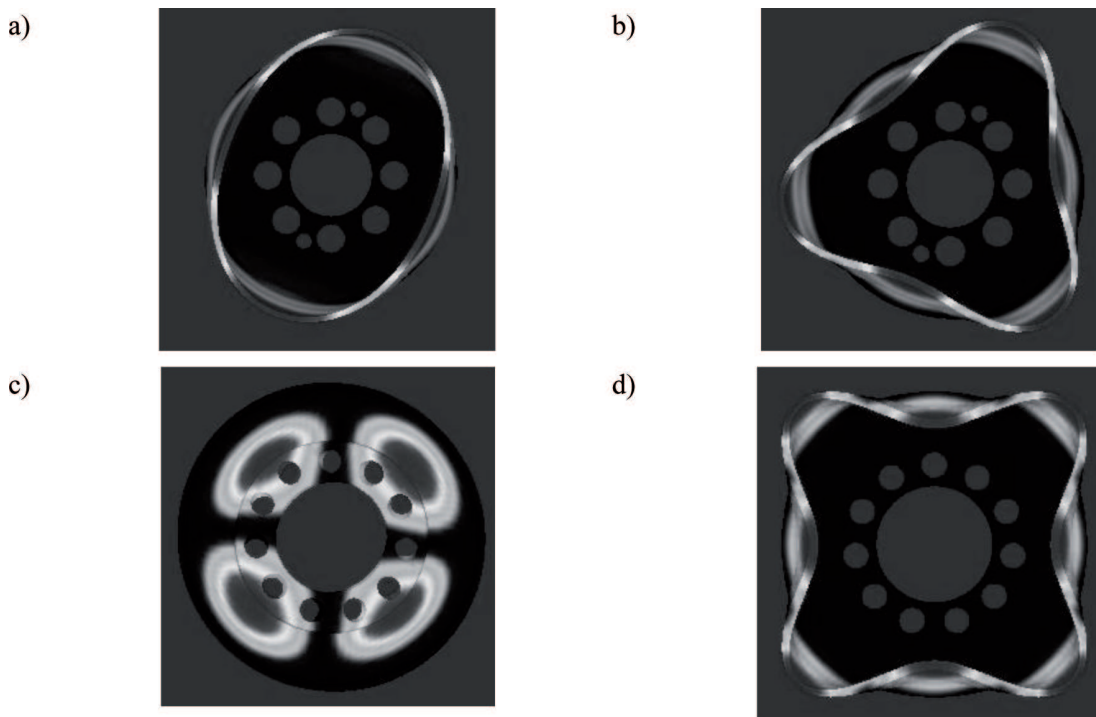

Fig. 9. Shape of the steel flexspline: a) first, b) fourth, c) fifth, d) sixth

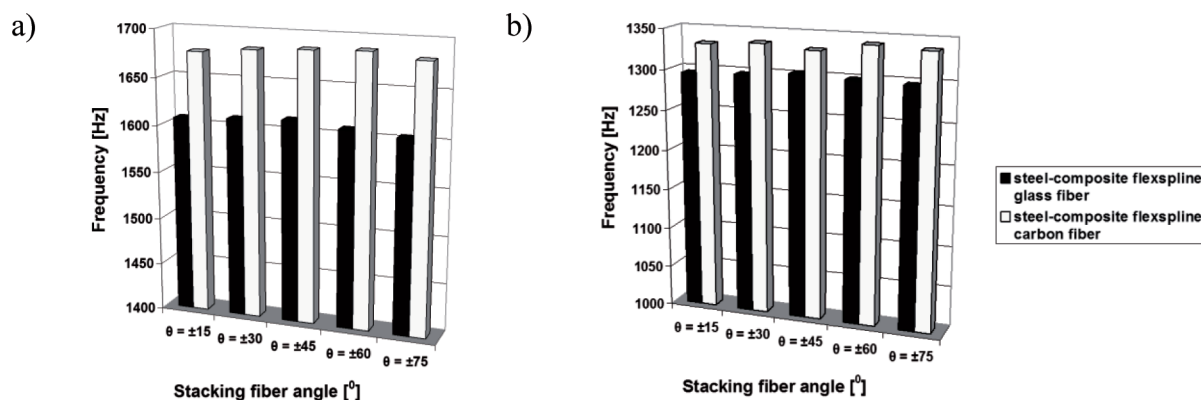

Fig. 10. The first natural frequency of the steel-composite hybrid flexsplines depending on stacking fiber angle: a) a cup-type, b) with an outer flange

4. Summary

Using the finite element method a numerical analysis was performed for the steel and steel-composite hybrid flexsplines. The calculations have shown a reduction of maximum stresses in the analysed sections for the steel-composite hybrid flexsplines in comparison to the traditional steel flexsplines. The biggest decrease of stress values occurs when an epoxy resin reinforced by the carbon-fiber for the stacking fiber angle $\theta = \pm 75^\circ$ were used. When analysing the calculation results regarding proper vibration, it was found that the steel-composite hybrid flexsplines increases the value of vibration frequency in comparison with the steel flexsplines. Influence of the stacking fiber angle on the frequency of vibration for the tested flexsplines is negligible. The next stage of the research will consist of constructing a prototype of harmonic drive with a steel-composite flexspline and carrying out experimental tests.

REFERENCES

- [1] General Catalogue Harmonic Drive AG, 05.2009.
- [2] K.S. Jeon, D.G. Lee, Development of the composite flexspline for a cycloid-type harmonic drive using net shape manufacturing method, *Composite Structures* **32**, 557-565 (1995).
- [3] S.H. Oh, S.H. Chang, Improvement of the dynamic properties of a steel-composite hybrid flexspline of a harmonic drive, *Composite Structures* **38**, 251-260 (1997).
- [4] H.S. Jeon, S.H. Oh, S.H. Chang, A study on stress and vibration analysis of a steel and hybrid flexspline for harmonic drive, *Composite Structures*, **47**, 827-833 (1999).
- [5] K. Borysovska, D. Verbylo, Yu. Podrezov, M. Szafran, The structural optimization of ceramic-organic composites, *Archives of Metallurgy and Materials*, **54**, 4, 875-879 (2009).
- [6] M. Hebda, R.B. Pecherski, Energy-based criterion of elastic limit states in fibre-reinforced composites, *Archives of Metallurgy and Materials*, **50**, 4, 1073-1088 (2005).
- [7] P. Folęga, R. Burdzik, T. Węgrzyn, A.P. Silva, Using new materials for flexsplines of harmonic drive, *Engineering' 2009 – Innovation and development*, 5th Engineering Conference, Covilhã – Portugal (2009).
- [8] M.N. Ivanov, *Harmonic gear drive*, Moscow (1981).
- [9] W.N. Gorelov, Stress state of the teathed ring of harmonic drives flexible gear, *Soviet Engineering Research* **5**, 7-10 (1979).
- [10] S.A. Suvalov, V.N. Gorelov, Stress in the flexible gear by finite element method, *Soviet Engineering Research* **3**, 9-11 (1983).
- [11] V.A. Toropičjin, Stress-deformation analysis of the flexible gear of harmonic drive by finite element method, *Soviet Engineering Research* **2**, 17-18 (1988).
- [12] O. Kayabasi, F. Erzincanlı, Shape optimization of tooth profile of a flexspline for a harmonic drive by finite element modelling, *Materials and Design* **28**, 441-447 (2005).
- [13] P. Folęga, A. Wilk, Dobór cech konstrukcyjnych tulei podatnej przekładni falowej z wykorzystaniem MES, *Przegląd Mechaniczny* **10**, 31-36 (2002).
- [14] P. Folęga, A. Wilk, Analiza numeryczna tulei podatnej z wykorzystaniem elementów kontaktowych MES, *ZN Pol. Śl., ser. Transport* **41**, 35-42 (2000).