

J. KUSIAK*, M. SKÓRA**, Ł. RAUCH*, D. SZELIGA*, M. PIETRZYK*

APPLICATION OF NUMERICAL AND PHYSICAL SIMULATION TO DESIGN OF THE BEST MANUFACTURING TECHNOLOGY FOR FASTENERS

ZASTOSOWANIE NUMERYCZNEJ I FIZYCZNEJ SYMULACJI DO PROJEKTOWANIA NAJLEPSZEJ TECHNOLOGII WYTWARZANIA ELEMENTÓW ZŁĄCZNYCH

The development of the best manufacturing technology for fasteners was the subject of this work. Physical and numerical simulations were used to evaluate various technological variants. Possibility of application of new generation bainitic steels was considered, as well. Improvement of exploitation properties was the objective of the optimization having in mind tool wear and manufacturing costs as constraints. Several fasteners were investigated but results for three parts, including Allen screw, screw anchors used to carry concrete plates are presented as a case study. Industrial trials were performed and confirmed correctness of the designed manufacturing technology.

Keywords: forging, fasteners, optimization

Przedmiotem pracy była metodyka projektowania najlepszej technologii wytwarzania elementów złącznych. Różne warianty technologiczne były przedmiotem symulacji fizycznych i numerycznych. Rozważono również możliwość zastosowania nowych materiałów w postaci stali bainitycznych. Celem optymalizacji była poprawa własności eksploatacyjnych wyrobów natomiast zużycie narzędzi i koszty wytwarzania wprowadzono jako ograniczenia. Rozważono cały szereg elementów złącznych ale w pracy zamieszczono wyniki dla trzech wyrobów, a mianowicie śruby imbusowej, kotwy do betonu oraz niestandardowej śruby z kwadratową główką. Wykonane próby przemysłowe potwierdziły prawidłowość zaproponowanych technologii wytwarzania tych elementów.

1. Introduction

Fasteners are reliable parts and safety of people often depends on their quality. The fasteners are produced in multi operation cycles and design of the best manufacturing technology is a challenge. Contradictory criteria such as product properties, tool wear, environment protection and manufacturing costs have to be considered. Application of numerical and physical simulations to design the best manufacturing technology for fasteners is the topic of the paper.

Numerous examples of computer aided design of technology for a single forming process can be found in the literature. Papers dealing with modelling of the multi-stage forging have been published during the last fifteen years [1,2,3]. In some works a particular focus was on the analysis of workability during this process. Behrens et al. [4], Ghiotti et al. [5] and Bariani et al. [6] used numerical simulations to follow damage occurrence in few stages of forging. Chiesa et al. [7] presented optimization of forging with properties of product included in the cost function. All these papers dealt with a sequence of forging operations. The main task of the present work was considering the entire production chain. It is expected that this approach would provide possibility of accounting for re-

lations between subsequent operations [8,9,10]. Primary tests have shown that optimization of the full manufacturing chain, although theoretically possible, would require extremely long computing times. Therefore, the main objective of this work was development of the optimization philosophy, which would require reasonable computing times and can be applied to industrial processes. Various possibilities of reduction of the optimization effort were considered. Developed strategy was applied to optimize manufacturing of three types of fasteners with various optimization criteria.

2. Manufacturing chain for fasteners and applied models

The whole manufacturing chain for fasteners (Fig. 1) is composed of hot rolling of rods, cooling, drawing, multi stage forging, heat treatment and finishing. Beyond this, several auxiliary operations like phosphatizing or annealing are applied. The model developed in earlier publications [3,10] allows to simulate the whole chain. The properties and microstructural parameters are transferred from one process to the next one. Simulations and industrial trials have shown that changes of selected parameters of the chain allow to improve properties of

* AGH UNIVERSITY OF SCIENCE AND TECHNOLOGY, AL. A. MICKIEWICZA 30, 30-059, KRAKÓW, POLAND

** GAWEL ZAKŁAD PRODUKCJI ŚRUB S.A., 36-073 STRAŻÓW, POLAND

product. Sensitivity analysis was applied to select the processes in the chain, which have the influence on product properties.

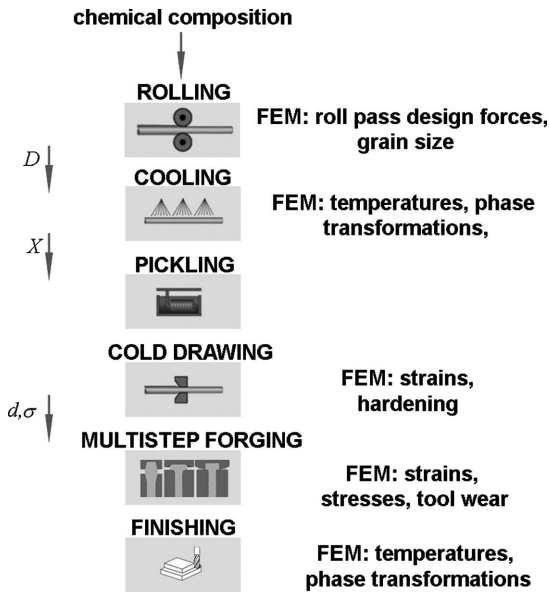

Fig. 1. Schematic illustration of the manufacturing chain for fasteners; parameters transferred between the processes are: D – austenite grain size, X – volume fractions of phases, d – rod diameter, σ – flow stress

Two groups of materials were considered. The first was C-Mn steel, which is now used for manufacturing majority of fasteners. The second was bainitic steel, as an alternative for C-Mn steels in some applications. All simulations were performed using finite element (FE) method. Commercial code Forge and Authors in-house code were used. Several material models had to be developed to make the simulations realistic. Thus, flow stress model for hot and cold forming was determined on the basis of plastometric tests on Gleeble 3800 and the inverse analysis. Microstructure evolution model was based on fundamental works of Sellars [11] but coefficients in the equations describing recrystallization and grain growth were determined using inverse analysis of stress relaxation tests. Finally, phase transformation model was based on the JMAK equation with coefficients determined by the inverse analysis of results of dilatometric tests. All material models used in this work are given in paper [12].

3. Manufacturing chain for fasteners and applied models

Problem of optimization of metal forming processes has been investigated for decades and number of papers have been published, see review of these papers in [13]. The general output from this research was twofold. Simulations of manufacturing chains are common [1-10] and optimization task for the whole chain based on metal forming can be formulated. On the other hand, connection of the optimization methods with simulation of manufacturing chain requires unacceptably long computing times. It causes that researchers search for the possibility of reduction of these times. The general idea of the conventional optimization is shown on the top of Fig. 2. In the lower part of this figure optimisation philosophy based approach is presented and it includes various ways of reduction

of the optimization costs: improvement of the model performance, development of new optimization strategies and model reduction.

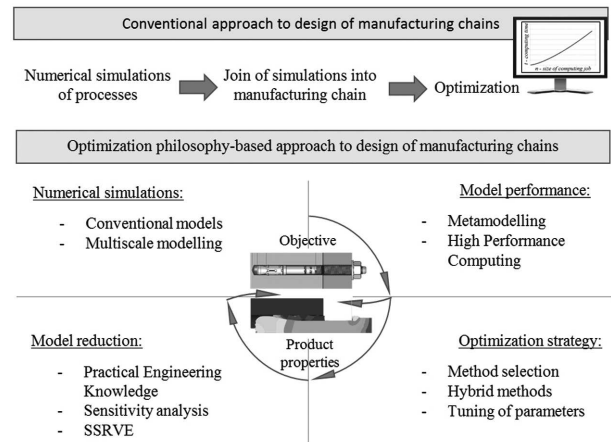

Fig. 2. Conventional and new approach to the manufacturing chain optimization

Model performance can be improved by application of the High Performance Computing (clusters) and by introduction of metamodeling which substitutes time consuming finite element models. **Optimization strategy** involves selection of the most effective method for the considered task, see papers [13,14]. **Model reduction** seems to be the most important possibility of decrease of the optimization costs. Among few possible methods sensitivity analysis and statistical representation of material microstructure (in multiscale modelling Statistically Similar Representative Volume Element (SSRVE) is used instead of RVE [15]) seem to be the most important in optimization of metal forming cycles. In the present work a new aspect was considered, which uses the practical engineering knowledge of experts in combination with optimization methods. Knowledge of experts allowed to constrain the search domain drastically and made optimization more efficient. Three cases of manufacturing cycles based of forging were considered and investigated in cooperation with technologists from one of the forging shops in Poland. Industrial trials were performed for validation of the optimal technologies.

4. Sensitivity analysis

Sensitivity Analysis (SA) investigates the model (process) behaviour for various input data and model parameters [16]. It determines how the variations of input data and parameters are distributed on the variations of model outputs and influence them. Due to high computational cost of the model, the lowest possible number of simulations was the criterion for the selection of the SA method. Two methods were applied. The first was two-level Factorial Design (FD), a global SA method, which allowed to estimate the general effects of the model parameters while the computational costs were much lower comparing to other global SA algorithms as Morris Design or Sobol' [16]. In the FD approach, the effect of model parameter on the model output y is calculated as:

$$Effect_{FD} = \frac{\sum y^+}{n^+} - \frac{\sum y^-}{n^-} \quad (1)$$

where: “+”, “-“ is the upper/lower limit of the parameter range, respectively (they define two levels of the parameter in the analysis); n – number of model simulations at each level.

Determination of the optimal process parameters was performed based on the FD effects using trial and errors method combined with an expert knowledge. The local sensitivities with respect to parameters were calculated to verify whether the estimated point is the optimum of the process. Local sensitivity with respect to the parameter x is defined as: $s_x = \partial y / \partial x$, where y is the model output. Determination of the s_x analytically for an industrial process is not possible, therefore forward and backward difference were applied to estimate sensitivity s_x .

5. Optimization of industrial processes and industrial trials

5.1. Manufacturing of the Allen screw M6×20

The objective of the optimization was to eliminate the following faults occurring in the products: i) Discontinuity of the surface below the head in the area of the transition radius (Fig. 3); ii) Misalignment between the fibres in the material and the shape of the screw. This misalignment causes cracks during product exploitation; iii) Misfit between surfaces at contact with joined material, which causes problems during assembly, in particular increase of the screw torque; iv) Misfit between axis of the hexagonal nest and axis of the bolt. Sensitivity analysis has shown that hot part of the manufacturing chain has no influence on the listed faults and only cold drawing and forging were investigated.

The objective function included maximum of the contact surface in the zone D (Fig. 3) and direction of fibres along the surface. Optimization variables were: number of operations (according to the trial and error method controlled by the experience of the technologists), rod diameter (d) after drawing and displacement of the upper tool (g) in the 3rd operation. The domain of the optimization variables was constrained by the experience of the technologist. Numerical optimization for the constrained variables gave $d = 6$ mm, $g = 2.7$ mm and forging technology with additional operation shown in Fig. 4 (bottom) was proposed. Strains in subsequent operation for the optimal technology and relation between tool displacement g and contact surface are shown in Fig. 5.

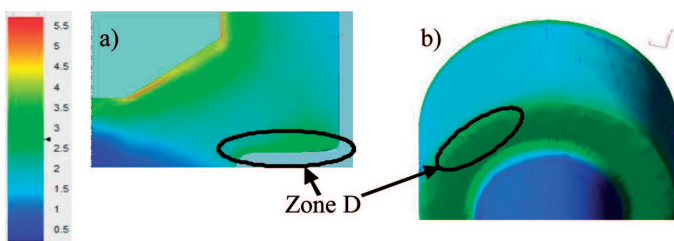

Fig. 3. Faulty contact surface in the area D. Colours represent strains

Industrial trials were performed for the optimal technology and noticeable improvement of the quality of products

was obtained. Contact surface was increased to its maximum value. Micrographs revealing the fibres in the semi products and in the final product after operations 3 and 4 in the new technology are shown in Fig. 6. It is seen that fibres are along the surface.

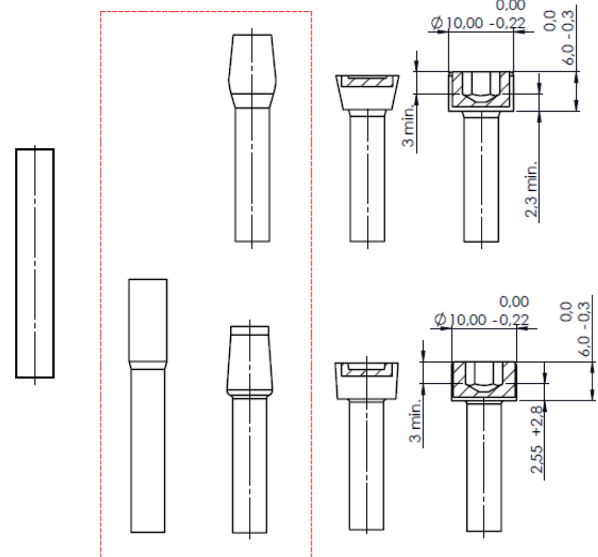

Fig. 4. Current (top) and optimized (bottom) forging sequence for the Allen screw

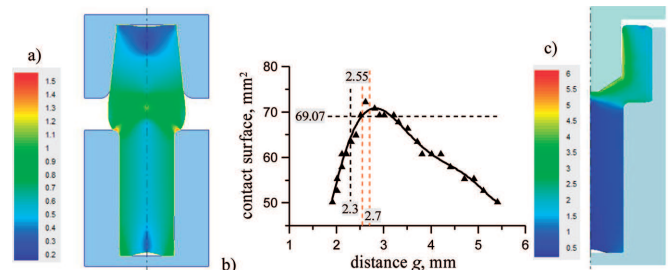

Fig. 5. Strains in operation 2 (a) and 4 (c) for the optimal technology and relation between tool displacement and contact surface (b)

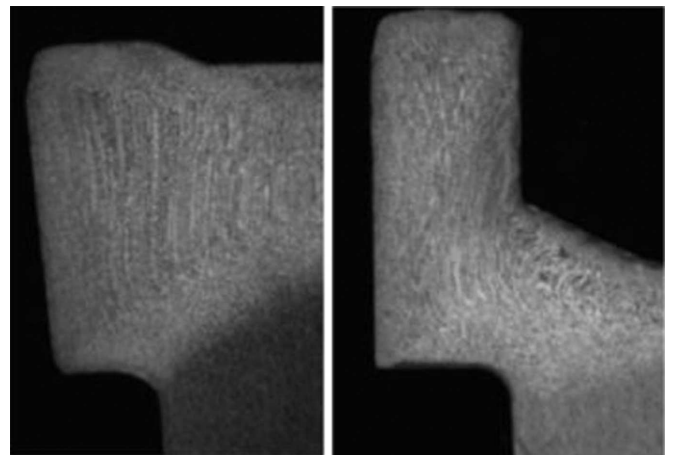

Fig. 6. Micrographs revealing the fibres in the semi products and in the final product after operations 3 and 4 in the new technology

5.2. Tool life as the optimization criterion in forging

Product properties are the main objective of the optimization, as shown in Fig. 2. Several constraints have to be considered during searching for the optimum, among which tool wear, costs of manufacturing and environmental protection are the most important. Basic information on the tool wear in forging and a review of the degradation mechanisms in forging tools was presented in [17]. It is shown in this publication that costs of tools are an essential part of the total manufacturing costs in hot forging. Therefore, problem of decrease of the tool wear during forging of the special screw was investigated next. The sliding tool wear model based on Archard law was used and only cold forming cycle was considered. The coefficient in this model was determined by inverse analysis of the measurements of the tool profile after forging of various numbers of parts in the industrial conditions, see [18] for details. Optimization variables were shapes of the intermediate tools and rod diameter after drawing. Optimization showed that the smaller is reduction in drawing, the lower is tool wear in forging. The forging technology which gave the minimum tool wear is shown in Fig. 7 (bottom). Differences in the character of distribution and in the level of stresses are well seen. The level of stresses at the last stage of the new technology does not exceed 900 MPa.

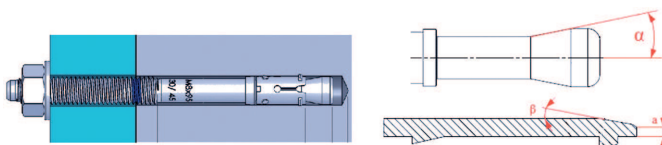

Fig. 7. Effective stresses at the cross section for subsequent operations according to the current (top) and optimal (bottom) technology

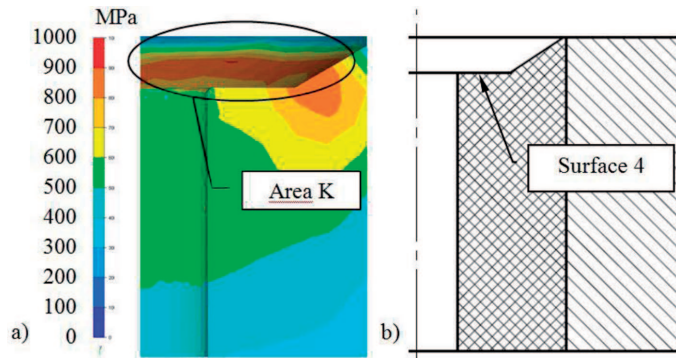

Fig. 8. Selected results of calculation of the die wear in the 3rd stage of the new technology (a) and the surface with maximum wear (c)

Selected results of calculations of the die wear in the 3rd stage of the new technology are shown in Fig. 8. Area K is a subject to maximum tool wear. Analysis of results showed that tool wear was noticeably decreased in the new technology. Comparison of the tool wear for the two technologies is given in Table 1. The total cost of tools for 10 000 000 pieces decreased by 12%.

TABLE 1

Tool wear for subsequent stages (S) and technological variants (V) obtained from simulation (* – tools in anvil, # – tools in sidle)

V	S	Tool wear mm/piece	Limiting wear mm	Number of tools for 10 mln pieces	Unit tools cost Euro
1	1*	3.076×10^{-10}	0.04	7.7	48
	2*	0.593×10^{-10}	0.04	1.5	21
	3*	0.747×10^{-10}	0.04	1.9	33
	4*	0.989×10^{-10}	0.05	2.0	60
	4#	0.333×10^{-8}	0.05	66.7	6.0
	5#	0.5×10^{-8}	0.07	71.4	9.0
	Total cost (euro) for 10 mln pieces				
2	1*	3.076×10^{-10}	0.04	7.7	48
	2*	0.593×10^{-10}	0.04	1.5	21
	3*	0.692×10^{-10}	0.04	1.7	40
	4*	1.098×10^{-10}	0.05	2.2	60
	4#	0.166×10^{-8}	0.05	33.3	6.0
	5#	0.5×10^{-8}	0.07	71.4	9.0
	Total cost (euro) for 10 mln pieces				

5.3. Optimization of manufacturing of anchors

Anchors are used as joints with the concrete plates (Fig. 9) and strength of the joint was the main optimization criterion. In this case possibility of application of bainitic steel as an alternative for the currently used C-Mn steel was considered. Advantages of bainitic steels as material for forgings (in particular fasteners) are discussed in [12]. Introduction of the new steels involved necessity of simulation of the whole manufacturing chain, including its hot part.

Optimization of the hot rolling of rods was performed with the uniform austenite grain size as the objective function. Sensitivity analysis has shown that within practically observed grain size its effect on phase transformation during cooling is small [16] and further analysis focused on accelerated cooling in the STELMOR system. The objective was to obtain granular bainite at the whole cross section of the rod. It was shown in [12] that the microstructure with small and uniformly distributed martensite-austenite (MA) particles in the bainitic ferrite matrix, is the most suitable for cold forming. The second phase should be composed of the retained austenite in the outer layer and products of incomplete austenite decomposition located in the centre of the rod.

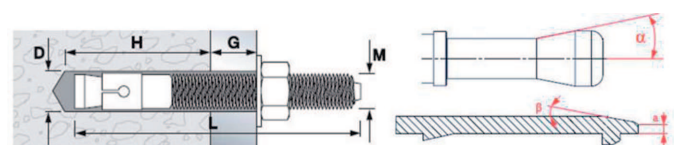

Fig. 9. View of the anchor and its characteristic dimensions

This microstructure should be obtained in the STELMOR system, which is a set of fans which cool wire rod in coils on the conveyer. After this accelerated cooling coils are put into special containers where cooling rate is significantly reduced. The objective is to obtain bainitic microstructure with some ferrite and martensite and as uniform as possible distribution of volume fractions along the rod radius. The objective function in the present work was formulated as:

$$\Phi = \sqrt{w_1 \delta^2 + w_2 \left(\frac{F_b - F_{b0}}{F_{b0}} \right)^2 + w_3 \left(\frac{F_m - F_{m0}}{F_{m0}} \right)^2} \quad (2)$$

where: F_b , F_m – volume fractions of bainite and martensite, respectively, F_{b0} , F_{m0} – required volume fractions of bainite and martensite, respectively, w_1, w_2, w_3 – weights, δ - inhomogeneity of bainite volume fraction distribution.

In the case study in the present work the required volume fractions at the centre of the rod were $F_b = 0.75$ and $F_m = 0.17$. Inhomogeneity of volume fraction distribution was represented by $\delta = (F_{bcentre} - F_{bsurface})/F_{bcentre}$, where indices refer to the centre and the surface of the rod. The design variables in the optimization were entry temperature T_e to the cooling system, time of cooling t_c , intensity of fans represented by heat transfer coefficient h_f and wire-rod diameter d . The reference calculations for arbitrarily assumed $T_e = 820^\circ\text{C}$, $t_c = 14$ s, $h_f = 600$ W/m²K gave $F_b = 0.72$ and $F_m = 0.23$. Sensitivity analysis of the volume fraction of phases with respect to the design variables using FD method was performed, see results in Figure 10a.

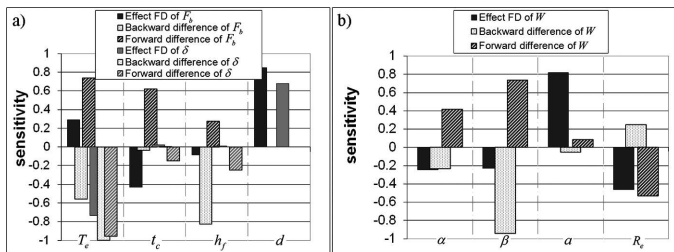

Fig. 10. Sensitivities for the cooling in the STELMOR system (a) and sensitivities of the strength of the anchor-concrete joint with respect to the shape parameters and properties of the expansion sleeve material (b)

These results allowed to evaluate influence of the design variables on the model output and were used in optimization of the accelerated cooling for $d = 12$ mm. The optimization gave the minimum of the objective function ($F_b = 0.75$, $F_m = 0.17$ and $\delta = 0.048$) for $T_e = 818^\circ\text{C}$, $t_c = 15$ s and $h_f = 590$ W/m²K. These results were confirmed by the local SA, in which calculated backward and forward difference have opposite signs for all design variables, see Fig 10a. Obtained result is not optimal for the homogeneity of phase composition, but the obtained value of $\delta = 0.048$ is acceptable.

Results of optimization of cooling were further connected with the cold forming part of the cycle and with optimization of exploitation properties of the product. Sequence of calculations was composed of drawing, forging and strength test for the joint. FE Forge code was used for simulation of forming processes, as well as the test of pulling out the anchor from the concrete plate. Parameters which were transferred between

processes included volume fraction of phases and resulting flow stress, rod diameter and shape of the anchor. The last parameter was represented by the angle of the cone (α), angle of the expansion sleeve (β), and thickness of the expansion sleeve (a), see Fig. 9. Optimization of the shape of the anchor with respect to the strength of the joint should be performed next. It was preceded by the sensitivity analysis with respect to the shape parameters and to the yield stress (R_e) of the sleeve material and the results are shown in Fig. 10b. Since all the local sensitivities have opposite signs it was concluded that current anchor dimensions are optimal with respect to the strength of the anchor-concrete joint.

6. Conclusions

Optimization of manufacturing chains based on metal forming, although theoretically possible, requires extremely long computing times and is not acceptable in practice. New strategy was proposed. It takes advantage of the sensitivity analysis and model reduction and is combined with variant optimization. This strategy was applied to improve technology for three manufacturing chains for fasteners. The major conclusions from the research are as follows:

- Applied variant optimization allowed to improve the assembly properties of the screw and to decrease the tool costs by 12%.
- Combination of the sensitivity analysis and conventional optimization allowed to find, in a reasonable time, the cooling schedule, which gives required phase composition of the wire for anchors. It also confirmed that current dimensions of the anchor give the maximum strength of the joint.
- Industrial trials confirmed efficiency and reliability of the proposed optimization methodology for investigated cases.

Acknowledgements

The work was performed within the AGH project no. 11.11.110.300.

REFERENCES

- [1] C. McCormack, J.A. Monagan, 2D and 3D finite element analysis of a three stage forging sequence, *Journal of Materials Processing Technology* **127**, 48-56 (2002).
- [2] K.S. Park, C.J. Van Tyne, Y.H. Moon, Process analysis of multistage forging by using finite element method, *Journal of Materials Processing Technology* **187-188**, 586-590 (2007).
- [3] M. Pietrzyk, Ł. Madej, S. Węglarczyk, Tool for optimal design of manufacturing chain based on metal forming, *CIRP Annals Manufacturing Technology* **57**, 309-312 (2008).
- [4] A. Behrens, H. Just, D. Landgrebe, Prediction of cracks in multistage cold forging operations by finite-element simulations with integrated damage criteria, *Proc. Metal Forming 2000*, publ. A.A. Balkema, Kraków, 245-252 (2000).
- [5] A. Ghiotti, S. Bruschi, P.F. Bariani, Damage modelling in cold forging process chains, *Steel Research International*, Spec. ed.: 10th ICTP, Aachen, 919-922 (2011).
- [6] P.F. Bariani, S. Bruschi, A. Ghiotti, Physical simulation of longitudinal welding in porthole-die extrusion, *CIRP Annals Manufacturing Technology* **55**, 287-290 (2006).

- [7] M.L. Chiesa, R.E. Jones, K.J. Perano, T.G. Kolda, Parallel optimization of forging processes for optimal material properties, Proc. Conf. NUMIFORM, eds, S. Ghosh, J.C. Castro, J.K. Lee, American Institute of Physics, Columbus, 2080-2084 (2004).
- [8] K.K.B. Hon, S. Xu, Impact of product life cycle on manufacturing systems reconfiguration, *Annals of the CIRP* **56**, 455-458 (2007).
- [9] J. Pereira, B. Paulre, Flexibility in manufacturing systems: a relational and a dynamic approach, *European Journal of Operational Research* **130**, 70-82 (2001).
- [10] M. Skóra, S. Węglarczyk, J. Kusiak, M. Pietrzyk, Computer aided design of manufacturing of fasteners – selection of the best production chain, *Key Engineering Materials* **504-506**, 157-162 (2012).
- [11] C.M. Sellars, Physical metallurgy of hot working, in: Hot working and forming processes, eds, C.M. Sellars, G.J. Davies, The Metals Soc., London, 3-15 (1979).
- [12] R. Kuziak, V. Pidvysots'kyi, S. Węglarczyk, M. Pietrzyk, Bainitic steels as alternative for conventional carbon-manganese steels in manufacturing of fasteners – simulation of production chain, *Computer Methods in Materials Science* **11**, 443-462 (2011).
- [13] M.H.A. Bonte, A.H. van den Boogaard, J. Huetink, An optimisation strategy for industrial metal forming processes, *Structural and Multidisciplinary Optimization* **35**, 571-586 (2008).
- [14] W. Kuś, W. Mucha, Idea of the optimization strategy for industrial processes, *Computer Methods in Materials Science* **14**, 13-19 (2014).
- [15] Ł. Rauch, R. Kuziak, M. Pietrzyk, From high accuracy to high efficiency in simulations of processing of Dual-Phase steels, *Metallurgical and Materials Transactions B* **45B**, 497-506 (2014).
- [16] D. Szeliga, Identification problems in metal forming: A comprehensive study, publ. AGH University of Science and Technology, no. 291, Krakow (2013).
- [17] Z. Gronostajski, M. Kaszuba, M. Hawryluk, M. Zwierzchowski, A review of the degradation mechanisms of the hot forging tools, *Archives of Civil and Mechanical Engineering* **14**, 528-539 (2014).
- [18] M. Skóra, S. Węglarczyk, M. Pietrzyk, Numerical simulation of tool wear as support of optimization of manufacturing chain for fasteners, *Computer Methods in Materials Science* **13**, 68-76 (2013).