

INFLUENCE OF Mg CONTENT ON DEFORMABILITY OF AlMg ALLOYS DURING EXTRUSION

In this study the research on deformability of AlMg alloys with high Mg contents in extrusion was carried out. The different shapes from AlMg alloys containing 3.5%, 4.5% and 5.5% of Mg were extruded on 500 T semi-industrial press by using one-hole and multi-hole flat dies. The extrudates surface quality was under investigations in relation with the temperature-speed parameters of the extrusion process. The metal exit speed was estimated depending on the extrudates shape, wall thickness and Mg content. The alloy's border solidus and liquidus temperatures were also determined.

Keywords: extrusion, AlMg alloys, deformability, metal exit speed, surface quality

1. Introduction

The deformability is defined as a resistance of metal or alloy to deformation and, at the same time, as a limit value of deformation before the loss of metal cohesion. The knowledge of deformability is the base for design of the metal working process parameters. For such processes like rolling or forging the deformability is described by the force needed to deformation and the maximal deformation value.

In the case of extrusion the extrudability is represented by extrusion load and maximal exit speed of the metal from the die [1]. In the aluminium extrusion practice the extrusion load is not a limit, so the principal problem here is the maximization of the metal exit speed. Because of that in this work as deformability ratio of AlMg alloys (5XXX series) the maximal exit speed of the metal was assumed in dependence on the process parameters and the shape of an extrudate. The literature data on the possible exit speeds for the AlMg alloys in table 1 are given [1-2]. The prior investigation of the authors permitted to evaluate the limit exit speed during semi industrial extrusion of the flat shapes from the AlMg4,5 and AlMg5,5 alloys with the use of two-hole die [3].

TABLE 1
Metal exit speed V_{1max} during extrusion of AlMg alloys with different Mg contents

Alloy	V_{1max} [m/min]	
	[1]	[2]
AlMg1	30 – 75	30 – 70
AlMg3	3 – 6	5 – 15
AlMg5	1 – 3	1,5 – 3

In design of extrusion of the hard alloys, like 5XXX series alloys with high Mg content, we select the speed – temperature

parameters [4-5]. We base on the dependence of the maximal exit speed on temperature as shown schematically in Fig.1. The region under the limit curves A and B specifies possible temperature-speed parameters in the extrusion process. In this region the most favorable temperature-speed parameters are hatched. Theoretically, the best conditions occur at the intersection of the curves A and B.

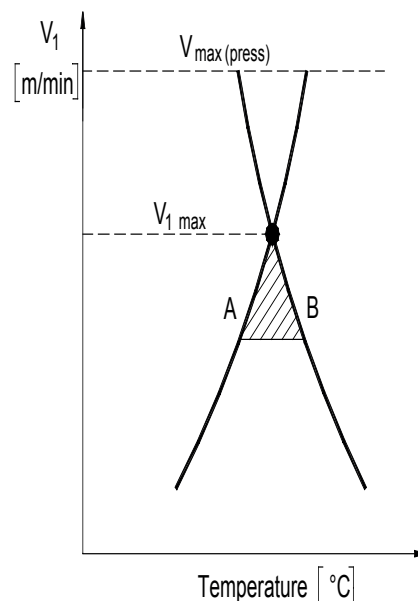

Fig. 1. Schematic diagram for determining the optimum temperature-speed parameters of the extrusion process. A – curve representing force capacity of the press, B – curve representing the limit values of deformation (without cracking of the alloy exiting the die opening)

The main goal of the work is to give the answer what is the influence of the Mg content on the deformability of 5XXX series alloys in the extrusion process. Beside of the Mg content the role of the extrudate shape was also analysed.

2. Extrusion billets

The AlMg alloys with high magnesium content of 3.5%, 4.5% and 5.5% were used in investigations. The billets were prepared in the Institute of Non-Ferrous Metals – Light Metal Division in Skawina in semi-industrial conditions. The cast process was carried out using semi continuous vertical method to obtain billets of 105 mm in diameter. The chemical compositions of the alloys EN AW-5754 (3.5% Mg), EN AW-5083 (4.5% Mg) and EN AW-5019 (5.5% Mg) according to the PN-EN 573-3:2010 standard are given in table 2.

The billets were next submitted to homogenization in the following conditions:

- the alloys EN AW-5754 and EN AW-5083: heating up to 410°C for 4hours, keeping for 2h at this temperature, next heating up to 530°C for 1h and keeping at this temperature for 12h,
- the EN AW-5019: heating up to 410°C for 4hours, keeping for 4h at this temperature, next heating up to 530°C for 1h and keeping at this temperature for 14h.

After homogenization the billets were cooled down in the air. The course of the homogenization operation in the form of temperature- time dependence is shown in Fig. 2.

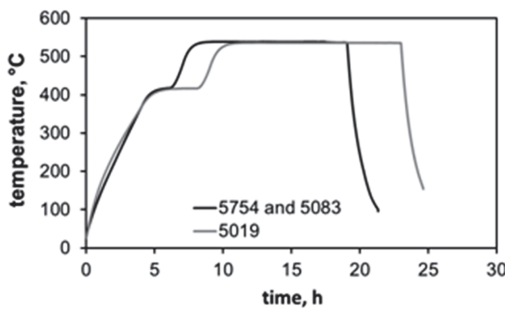

Fig. 2. Curves temperature-time registered during homogenization of billets from AlMg alloys with high Mg content

3. Calorimetric testing

The calorimetric test was carried out to measure the limit liquidus and solidus temperatures of the alloys. The scanning calorimeter (DSC) of the Mettler Toledo Company was used in the experiments. The samples in the form of cylinder of 5 mm in diameter and mass of 37.7–52 mg were placed in the crucible from the aluminium oxide. The measurement consisted in determination of the heat effect during heating from 390°C up to 700°C, and next during cooling down to 390°C. The heating and cooling operation were carried out with the speed of 20°C/min. The tests were performed in the argon atmosphere.

The results of measurements in the form of calorimetric curves are shown in Fig. 3a – c. The endo- and exothermic effects arising from the melting and solidification of the tested alloys are visible. For the each alloy beginning of both melting (solidus temperature) and solidification (liquidus temperature) were determined and are shown in table 3 and Fig.4. In addition, the differences between solidus and liquidus temperature for the as cast (S) and homogenized (H) samples were obtained.

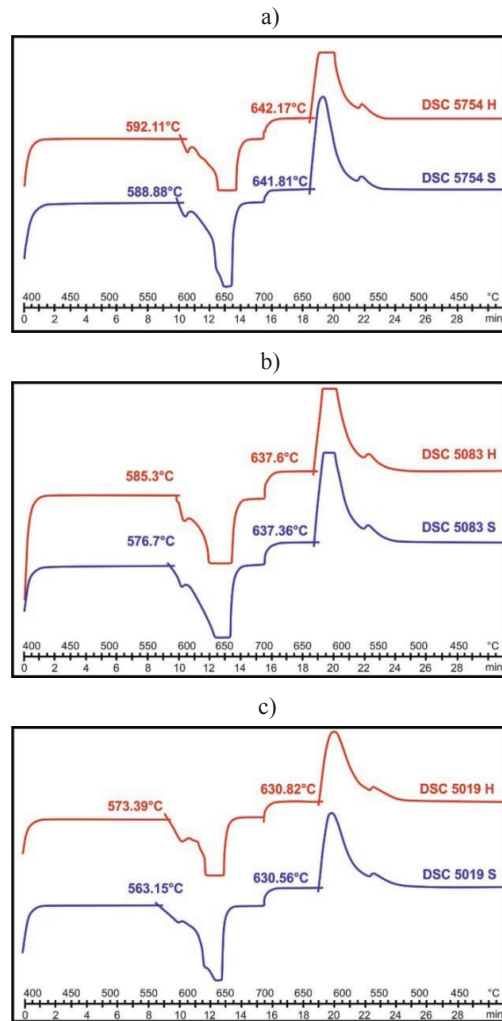

Fig. 3. DSC calorimetric curves for AlMg alloys with different Mg contents. a) 3.5% Mg (5754 alloy) b) 4.5% Mg (5083 alloy) c) 5.5% Mg (5019 alloy)

The decreasing of the both liquidus and solidus temperatures was observed with the increase of Mg content in the alloy. The liquidus temperature does not depend on the state of the alloy, and for the each of the alloys tested in the as cast state as well as after homogenization is at the same level. From the point of view of design of homogenization

TABLE 2

Chemical compositions of AlMg alloys intended for extrusion process, % mass

Alloy	Fe	Si	Cu	Zn	Ti	Mn	Mg	Cr
EN AW-5754	0,14	0,224	0,007	0,022	0,018	0,465	3,44	0,002
EN AW-5083	0,145	0,229	0,004	0,024	0,018	0,553	4,44	0,12
EN AW-5019	0,146	0,246	0,004	0,026	0,019	0,567	5,54	0,002

TABLE 3

Summary of liquidus and solidus temperatures for AlMg alloys in different states (S – as-cast, H – homogenized)

Alloy	5754 S	5754 H	5083 S	5083 H	5019 S	5019 H
Liquidus, °C	642	642	637	638	631	631
Solidus, °C	589	592	577	585	563	573
Solidus H – Solidus S, °C	3		8		10	

conditions and their control the most important are differences between the solidus temperature in the as cast state and after homogenization. For the analysed alloys, namely EN AW-5754, EN AW-5083, EN AW-5019 the differences are: 3°C, 8°C and 10°C respectively (table 2) – the increase in the difference is observed as magnesium content in the alloy increases.

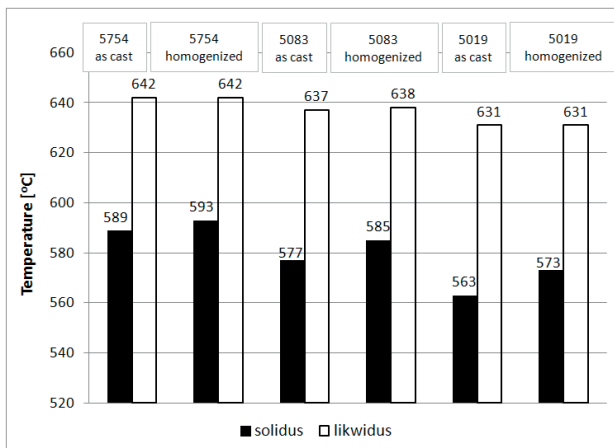

Fig. 4. The solidus and liquidus temperatures of the AlMg alloys – as cast and after homogenization

4. Extrusion trials

The different solid shapes (fig. 5) from AlMg alloys containing 3.5%, 4.5% and 5.5% of Mg were extruded on 500 T semi-industrial press by using one-hole and multi-hole flat dies. The extrusion dies used in research were shown in Fig. 6. The metal flow was balanced by the proper arrangement of the holes on the die surface and/or by applying different bearing lengths. The example construction of extrusion dies were shown in Figure 7. The extrusion trials were performed for relatively high billet temperatures ($T_0 = 500^\circ\text{C}$ and 530°C) and a wide range of metal exit speed ($V_1 = 1\text{-}35$ m/min; depending of the Mg content in the alloy and the extrudates shape). The temperature of metal leaving the die opening was measured with the use of pyrometric measuring system installed on the press. The extrudates surface quality was under investigations in relation with the temperature-speed parameters of the extrusion process. The metal exit speed V_{1cr} (for which extrudates surface cracks appears) was estimated depending on the extrudates shape, wall thickness and Mg content. The applied parameters of extrusion process were showed in tables 4-7.

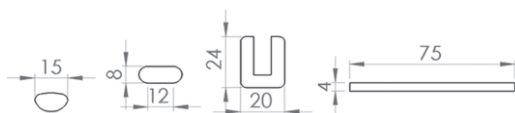

Fig. 5. The shapes of extruded sections



Fig. 6. The dies and backers (above) for extrusion of solid sections

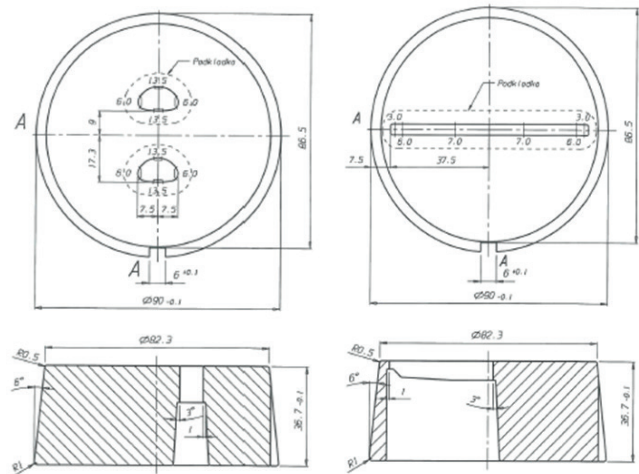

Fig. 7. Example die constructions for 2-hole extrusion of section of round type shape (on the left) and 1-hole extrusion of wide flat section (on the right)

5. Results and analysis

Performed tests of extrusion of solid sections from 5XXX aluminium alloys allowed for obtaining data on influence of the magnesium content and extrudate shape on exit speed of metal from the die.

Fig. 8 shows the example sections (No 1 and 3), which were obtained in the temperature-speed condition guarantying good surface quality of the product – without streaks, cracks or tearing. Worthy to note if the fact that the dies used were equipped with relatively long bearing lands, what increases hydrostatic pressure within the die orifice (positive from the material deformability point of view), but from the other hand, causes the rise of the extrudate temperature. In Fig. 8 a high geometrical stability of extrudates is observed, what confirms the uniformity of the metal flow from the die. This observation is valid for the all extruded profiles.

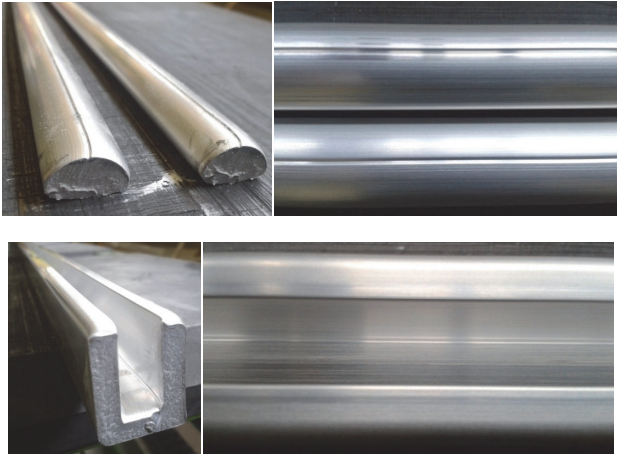

Fig. 8. Example sections (No 1 and No 3) extruded for properly matched temperature-speed parameters (good surface quality of extrudates)

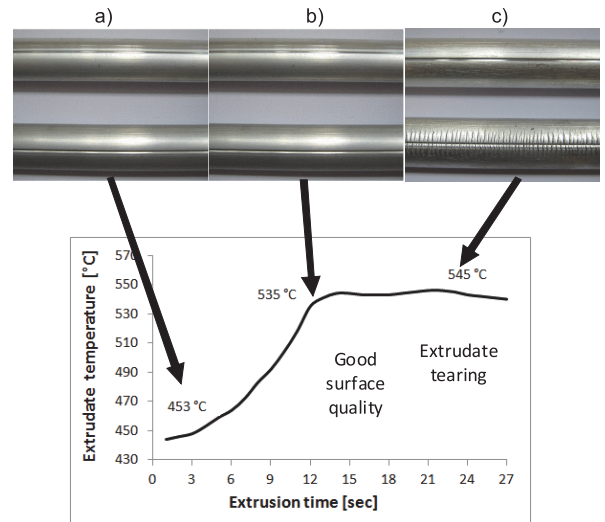

Fig. 11. Relation between extrudates surface quality and measured metal temperature on the length of extruded section No 1 for 5083 alloy ($V_1 = 13,4$ m/min). a) front part, b) middle part, c) back part

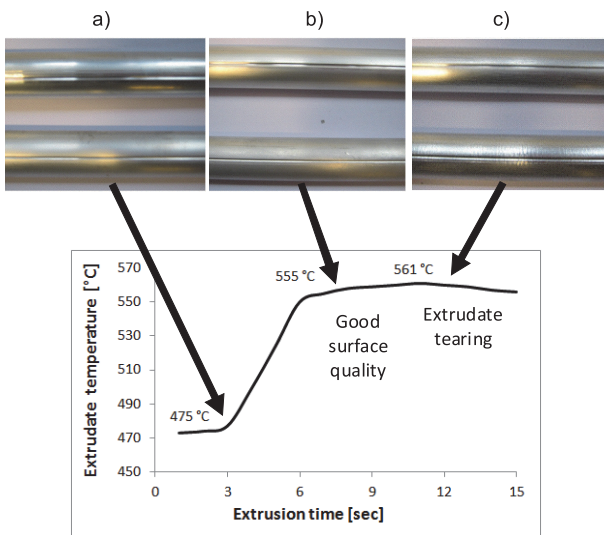

Fig. 9. Relation between extrudates surface quality and measured metal temperature along the length of extruded section No 1 for 5754 alloy ($V_1 = 31,2$ m/min). a) front part, b) middle part, c) back part

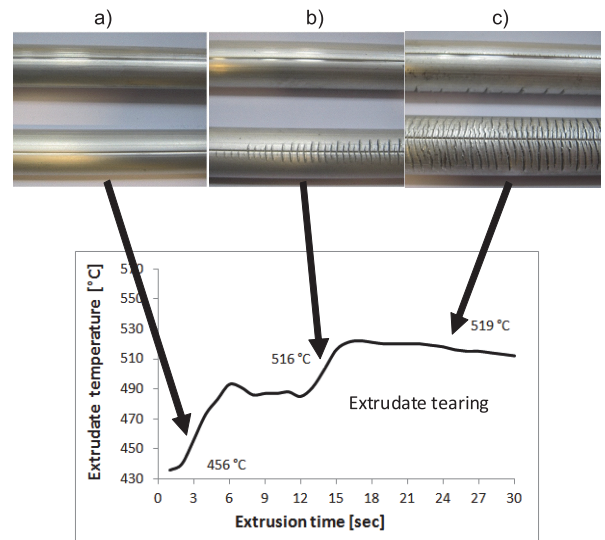

Fig. 12. Relation between extrudates surface quality and measured metal temperature on the length of extruded section No 1 for 5019 alloy ($V_1 = 8,9$ m/min). a) final part, b) middle part, c) back part

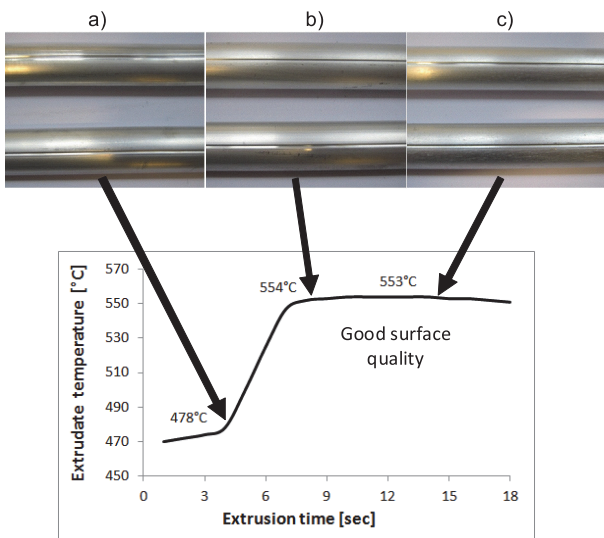

Fig. 10. Relation between extrudates surface quality and measured metal temperature on the length of extruded section No 1 for 5754 alloy ($V_1 = 22,3$ m/min). a) front part, b) middle part, c) back part

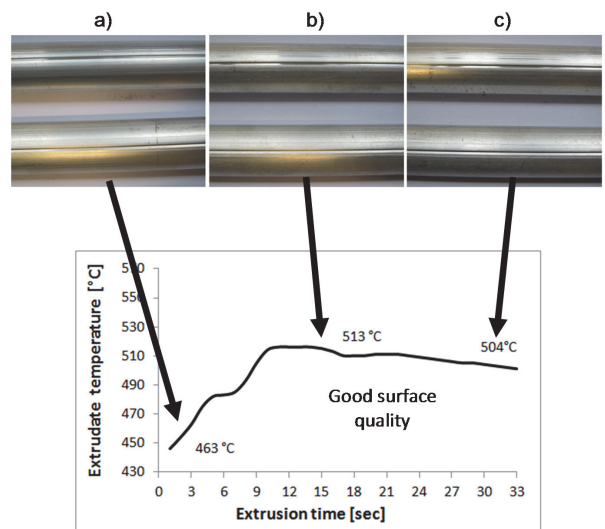

Fig. 13. Relation between extrudates surface quality and measured metal temperature on the length of extruded section No 1 for 5019 alloy ($V_1 = 6,7$ m/min). a) front part, b) middle part, c) back part

Figs 9 -13 present the surface quality of the round type solid section (section No 1) in dependence on the temperature measured along the section for the AlMg alloys of different magnesium content (3.5%, 4.5% and 5.5%). In case of the 5754 alloy (3.5% Mg) extruded with high exit speed ($V_1 = 31,2$ m/min), the fine cracks can be observed when the exit temperature reached 561°C (Fig. 9). For the slightly lower temperature - 555°C (middle of the extrudate) none cracking was observed. The decreasing of the exit speed down to $V_1 = 22,3$ m/min resulted in slightly lower temperature of the extruded material (ca. $553\text{-}554^\circ\text{C}$ at the end of the process, what allowed for receiving proper surface quality along the entire product (Fig. 10). As it results from the Fig 11 the loss of material cohesion takes place already at about 545°C for the exit speed of $V_1 = 13,4$ m/min). The safe extrusion temperature seems to be 535°C , for which good surface quality was obtained.

For the 5019 alloy (5.5% Mg) the more lower temperature-speed conditions were obtained (Figs 12 -13). The numerous cracks were observed at the middle and end part of the extrudate at the temperature of $516\text{-}519^\circ\text{C}$ and for the exit speed of $V_1 = 8,9$ m/min (Fig. 12). The lowering of the exit speed down to $V_1 = 6,7$ m/min resulted in decreasing of the extrudate temperature to $504\text{-}513^\circ\text{C}$, and in consequence, the process was safe from the surface quality point of view (Fig.13).

Fig. 14 shows dependence of the metal exit speed V_{cr} on the magnesium content in the alloy. This dependence concerns the extrusion of the round type solid section (section No 1) for the extrusion ratio $R = 37$ and heating temperature of 530°C . The dependence visible in Fig.14 indicates strong decreasing of the exit speed with the increase of the magnesium content in the AlMg alloys. In case of the analysed profile the change in the Mg content from 3,5% up to 5,5% resulted in over 3 times lower exit speed from the die.

The magnesium content in the AlMg alloy influences the cracking temperature of the extruded product. The higher the magnesium content the lower temperature wat which the extrudate cracks. Fig 15 shows dependence of the cracking temperature of the extruded product on magnesium content in the 5XXX alloys. The course of this dependence is similar to the that of the solidus temperature when the magnesium content changes. It was found, that the difference between cracking temperature od solidus temperature for the alloy is of the order of $30\text{-}50^\circ\text{C}$. The higher the magnesium content the lower is this difference. It means, that AlMg alloys of lower Mg content can be safely extruded at the temperature closer to its solidus temperature compared to the alloys of higher Mg content.

The performed investigations allowed for predicting probable limit curves B, which describe the metal exit speed V_{cr} from the die in dependence on temperature of the metal exiting the die for the AlMg alloys of varying Mg content (Fig. 16). The alternative method for obtaining the real course of the limit curves B is described in works [6-7]. In Figs. 17 -19 the surface quality of the profiles No 2, 3 and 4 for the final parts of the extrudate is presented for the limited temperature-speed conditions of the extrusion process for the 5754, 5083 and 5019 alloys.

Parallel investigations were performed on the influence of the shape of the extrudate on the maximal exit speed for the particular alloy. Fig. 20 shows dependence of the metal exit speed V_{cr} on Mg content in the AlMg alloys for different

extruded shapes. For the shapes favorable for the receiving high exit speed the data were described by symbol $V_{1\text{ MAX}}$, whereas for the unprofitable cases their data were described by symbol $V_{1\text{ MIN}}$.

The another form of presentation of influence of the shape of extruded product on metal exit speed V_{cr} for the 5XXX series alloys can be relations presented in Fig. 21. For the simplicity, the favorable shape of extrudate is the round type one, whereas the unfavorable shape may be described by the high periphery to cross-section ratio and by varying wall thickness of the section. The simplest example of a such shape may be flat section of low thickness and high width. The data shown in Fig. 21 indicate the substantial influence of the extruded shape on the possible maximal exit speed. This confirms the discussed role of the Mg content. The important conclusion resulting from Fig.21 is that, for the higher Mg content the less important is the role the extrudate shape when the maximal exit speed is considered. In general, for the higher Mg content in the alloy the maximal exit speed is very low.

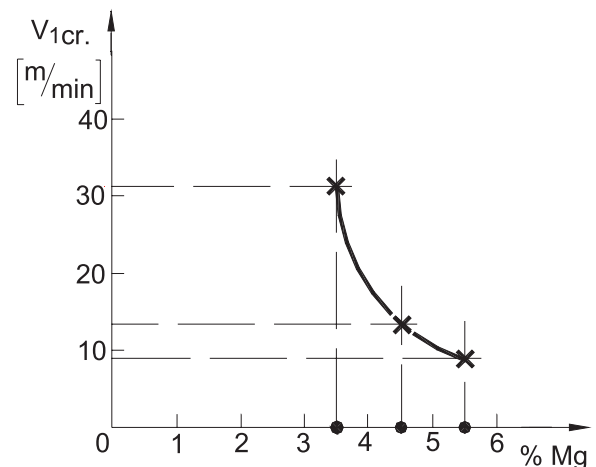

Fig. 14. Influence of Mg content in 5xxx series alloys on the metal exit speed V_{1cr} during extrusion of solid section No 1 (shape close to round)

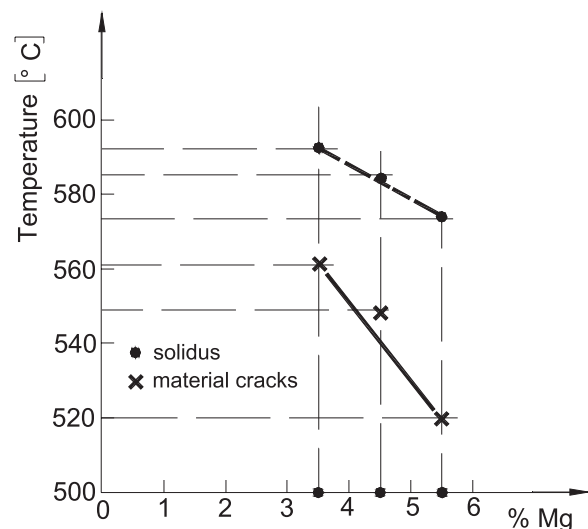

Fig. 15. Influence of Mg content in 5xxx series alloys on the cracking temperature of extruded section No 1 (shape close to round) and solidus temperature of the alloy

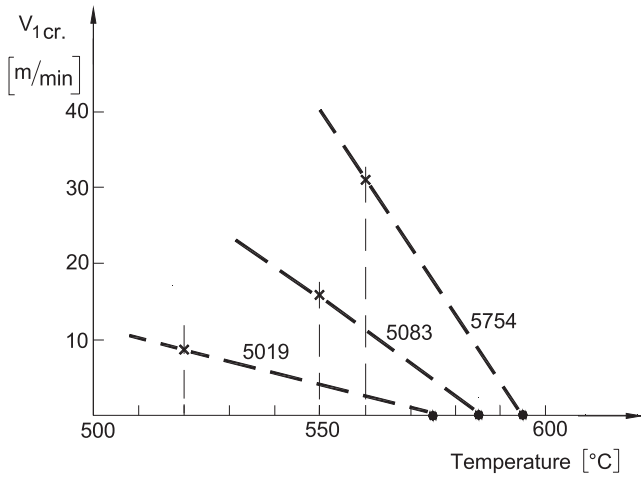

Fig. 16. Limit curves B representing the relation between metal exit speed V_{1cr} and temperature of metal leaving the die opening (section No 1 with round type shape) – for AlMg alloys with different Mg contents

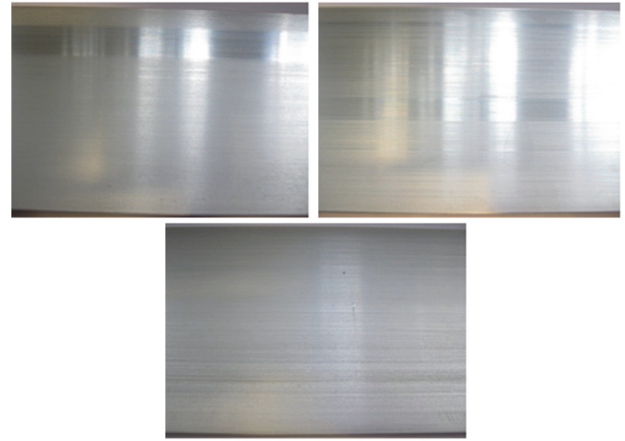

Fig. 19. Extrudates surface matt for the end part of section No 4 ($\lambda = 26,2$) a) 5754 alloy, $V_1 = 22$ m/min, $T_1 = 550$ °C, b) 5083 alloy, $V_1 = 6,3$ m/min, $T_1 = 527$ °C, c) 5019 alloy, $V_1 = 4,7$ m/min, $T_1 = 510$ °C

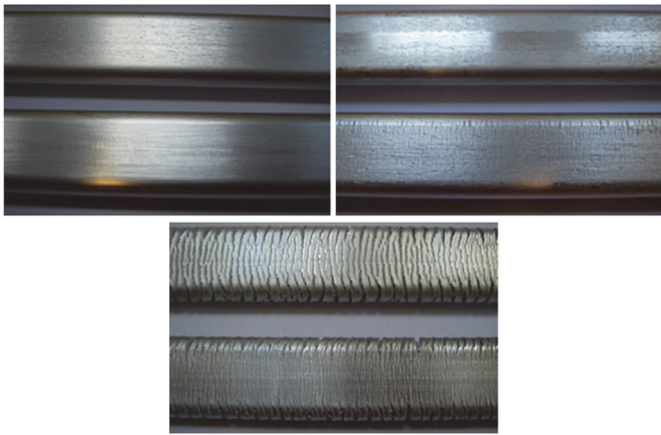

Fig. 17. Extrudates surface cracks for the end part of section No 2 ($R = 26,8$) a) 5754 alloy, $V_1 = 28,9$ m/min, $T_1 = 545$ °C, b) 5083 alloy, $V_1 = 12,9$ m/min, $T_1 = 545$ °C, c) 5019 alloy, $V_1 = 12,9$ m/min, $T_1 = 518$ °C

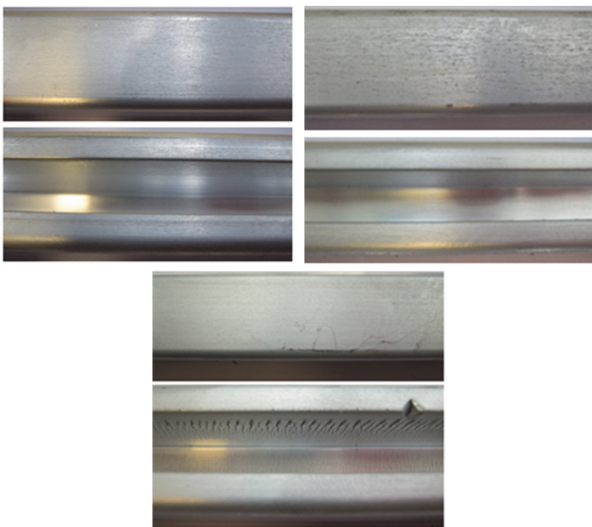

Fig. 18. Extrudates surface cracks for the end part of section No 3 ($\lambda = 23,4$) a) 5754 alloy, $V_1 = 19,6$ m/min, $T_1 = 556$ °C, b) 5083 alloy, $V_1 = 11,2$ m/min, $T_1 = 550$ °C, c) 5019 alloy, $V_1 = 8,4$ m/min, $T_1 = 533$ °C

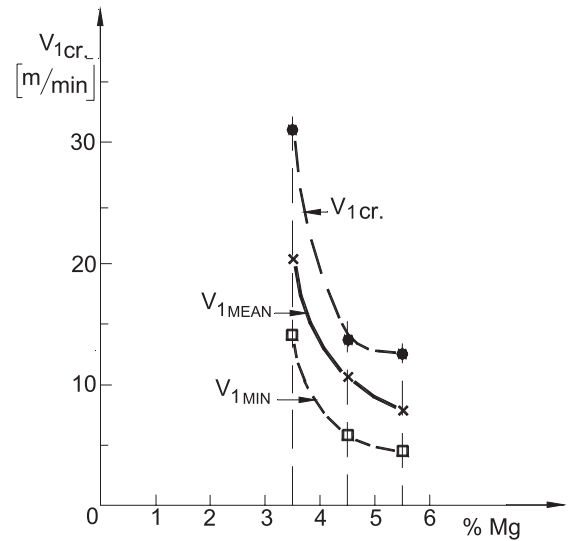

Fig. 20. Relation between the metal exit speed V_{1cr} and Mg content in AlMg alloys – for different extruded shapes

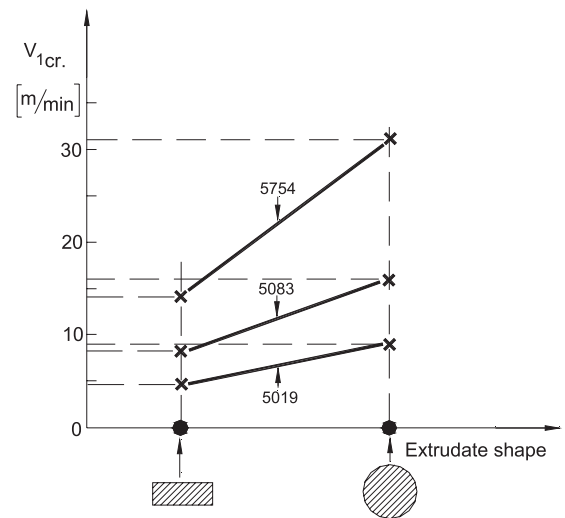

Fig. 21. The dependence of the metal exit speed V_{1cr} from the shape of extrudates – for AlMg alloy with different Mg contents

TABLE 4

Extrusion parameters for section No 1

Section No 1	Alloy	5754	5083	5019
	Billet diameter D_0 [mm]	Ø96		
	Billet length L_0 [mm]	140	140	100
	Die/ Extrusion ratio R [-]	flat 2-hole/37.1		
	Billet temperature T_0 [°C]	500 and 530		
	Extrudates temperature T_1 [°C]	528-561	520-550	494-520
	Metal exit speed V_1 [m/min]	4.5-42.4	4.5-13.4	4.5-8.9

TABLE 5

Extrusion parameters for section No 2

Section No 2	Alloy	5754	5083	5019
	Billet diameter D_0 [mm]	Ø96		
	Billet length L_0 [mm]	140	140	100
	Die/ Extrusion ratio R [-]	flat 2-hole/26.8		
	Billet temperature T_0 [°C]	500 and 530		
	Extrudates temperature T_1 [°C]	528-545	495-545	498-518
	Metal exit speed V_1 [m/min]	9.6-28.9	3.2-16.1	3.2-12.9

TABLE 6

Extrusion parameters for section No 3

Section No 3	Alloy	5754	5083	5019
	Billet diameter D_0 [mm]	Ø96		
	Billet length L_0 [mm]	140	140	100
	Die/ Extrusion ratio R [-]	flat 1-hole/23.4		
	Billet temperature T_0 [°C]	500 and 530		
	Extrudates temperature T_1 [°C]	543-556	532-550	496-533
	Metal exit speed V_1 [m/min]	8.4-19.6	4.2-11.2	2.1-8.4

TABLE 7

Extrusion parameters for section No 4

Section No 4	Alloy	5754	5083	5019
	Billet diameter D_0 [mm]	Ø96		
	Billet length L_0 [mm]	140	140	100
	Die/ Extrusion ratio R [-]	flat 1-hole/26.2		
	Billet temperature T_0 [°C]	500 and 530		
	Extrudates temperature T_1 [°C]	541-550	502-527	491-510
	Metal exit speed V_1 [m/min]	12.6-22	3.1-6.3	2.4-4.7

6. Conclusions

On the base of the analysis of the semi-industrial extrusion test on the AlMg alloys the following conclusion can be drawn:

1. The maximal exit speed from the die strongly depends on Mg content in the alloy. The increase of the Mg content from 3,5 up to 5,5% results in about 3 –times lower exit speed from the die.
2. The higher Mg content the lower temperature of the safe extrusion (without cracking).
3. The maximal exit speed for particular Mg content depends on the shape of extruded section. The round type sections can be extruded faster compared to the sections with high periphery to cross-section ratio. The higher Mg content the lower influence of the extruded section shape on maximal exit speed from the die.
4. The use of die with varying bearing lands (relatively long) resulted in the uniform metal flow from the die, and in consequence, high geometrical stability of the all extruded sections from the AlMg alloys of high Mg content (3,5-5,5%) was obtained. Taking into account

relatively high flow stress value of AlMg alloys and their tendency to sticking the shorter bearing lands are recommended. There is no risk of deformability drops of the alloys because the less favorable state of stresses within the die orifice is balanced by lower temperature of the extruded material.

5. The higher temperature rise is expected during industrial extrusion of the AlMg alloys when the billets of high dimensions are extruded (200 ÷ 300 mm in diameter and 800 ÷ 900 mm long). This can result in lower exit speed of the metal from the die. This phenomenon yields from the another heat balance of billets of high volume, particularly for the AlMg alloys, characterized by the low thermal conductivity. The obtained values of the maximal exit speed for AlMg alloys with different Mg content will be validated in the industrial conditions.

Acknowledgements

Financial support from National Centre of Research and Development under grant No: UOS-DEM-1-335/001 entitled “The development of innovative extrusion technology of hard-deformable AlMg alloys” (program DEMONSTRATOR+)

Received: 20 January 2015.

REFERENCES

- [1] K. Laue, H. Stenger, Extrusion – Process, Machinery, Tooling. ASM, Metals Park, Ohio 1981.
- [2] ASM Handbook, Aluminium and Aluminium Alloys, ASM International, 1993.
- [3] D. Leśniak, A. Rękas, W. Libura, J. Zasadziński, Badania odkształcalności stopów serii 5xxx o wysokiej zawartości Mg w procesie półprzemysłowego wyciskania, *Obróbka Plastyczna Metali*, vol. XXV, No. 3, ISSN 0867-2628, Wydawca Instytut Obróbki Plastycznej, pp. 159-167, Poznań 2014.
- [4] T. Sheppard, On the relationship between extrusion conditions, mechanical properties and surface acceptability in some hard aluminium alloys”, *Proc. 7th International aluminium extrusion technology seminar*, pp. 307-320, Chicago 2000.
- [5] B. Dixon, Extrusion of 2xxx and 7xxx alloys. *Proc. 7th International Aluminum Extrusion Technology Seminar*, p. 281-29, Chicago 2000.
- [6] J. Zasadziński, J. Richert, W. Libura, Temperaturowo-prędkościowe warunki wyciskania trudno odkształcalnych stopów Al, *Rudy Metale* (1977), nr 9, 456-460.
- [7] J. Zasadziński, J. Richert, W. Libura, W.Z. Misiólek, Modeling of Temperature-Speed Parameters in Aluminium Extrusion, *Proc. 5th Aluminium Extrusion Technology Seminar*, p. 385-393, Chicago 1992.