

EFFECT OF PARAMETERS OF HIGH-PRESSURE DIE CASTING ON OCCURRENCE OF CASTING NONCONFORMITIES IN SLEEVES OF SILUMIN ALLOY EN AB 47100

The paper presents a research on the effect of extreme – for the technology of the considered silumin EN AB 47100 – parameters of high-pressure die casting on occurrence of casting nonconformities. Considered was influence of the way of assembling the mould cooled-down to 140-160°C, non-standard for the selected casting, and pouring temperature in the range of 705 to 720°C (higher than the recommended) of non-refined alloy. The castings were prepared with use of a high-pressure casting machine made by Kirov with mould closing force of 2500 kN. Occurrence of nonconformities was evaluated on properly prepared specimens taken from the castings manufactured with various parameters of the injection piston and various multiplication pressures. The results were subjected to quantitative and qualitative analyses of casting nonconformities and distribution of major alloying elements. It was found that proper selection of working parameters of the casting machine, in spite of disadvantageous pouring conditions, makes it possible to reduce occurrence of some casting defects, like shrinkage cavities and porosity, to improve tightness of castings even when the alloy refining process is omitted.

Keywords: high-pressure die casting, casting nonconformities, structure, silumin, microhardness

1. Introduction

The alloy EN AB 47100 belongs to the most popular Al-Si alloys used in high-pressure die casting (HPDC) technique. Products made of the AlSi12Cu1(Fe) alloy are characterised by good strength and sufficient hardness, machinability, corrosion resistance and tightness [1-5]. Application field of these alloys includes automotive and aircraft industries, components of household articles and plumbing fixtures. In spite of well-known, very good properties of the alloy, casting irregularities related to restrictions of high-pressure die casting often occur in the products manufactured this way. Improvement of mechanical and technological parameters is obtained thanks to additional alloying elements: Cu, Mn and Mg. Copper results in better mechanical parameters and machinability, but reduces corrosion resistance and weldability. Manganese and magnesium improve mechanical properties and corrosion resistance [4,6].

High quality of the castings made by HPDC is certainly related to the three-stage process of pouring the mould cavity. Stage I is characterised by slow piston stroke whose task is to fulfil the mould volume. At the next II phase, piston speed is rapidly accelerated in order to remove possibly largest quantity of gases from the mould. The final III phase is distinguished by radical growth of pressure (multiplication) in order to “squeeze” metal in the mould cavity. While the first phase is of a relatively small importance for parameters of this way manufactured

castings, the other two influence quality of the products in a fundamental way [3].

Various settings of individual valves, responsible for the casting process, can influence quality of cast products and, when aided by analysis of structure and distribution of defects, can significantly increase competitiveness and profitability of the alloys for that the refining process was omitted [7].

2. Purpose and methodology of the research

In order to evaluate the effect of the final II and III phases of high-pressure casting on structure and casting irregularities of the selected product (Fig. 1), an attempt was made to cast it at extremely difficult process conditions.

Sleeves with wall thickness from 4 to 12 mm were cast of the alloy AlSi12Cu1(Fe) with composition given in Table 1, typical for this type parts. Casting was performed using a modernised HPDC machine Kirov 250 with full acquisition of casting parameters, among others piston speed and intensification (multiplication) pressure. Seven series three pourings each were carried-out, preceded by chemical analysis with an EDS analyser Oxford Instruments on the area of 0.964 mm². After cooling-down and removing gating systems, all the cast sleeves were machined on all their surfaces.

* WROCLAW UNIVERSITY OF TECHNOLOGY, WYBRZEŻE WYSPIANSKIEGO 25, 50-370 WROCLAW, POLAND

[#] Corresponding author: mateusz.stachowicz@pwr.edu.pl

Chemical composition of the alloy AlSi12Cu1(Fe) [8]: according to the standard – P and determined for the castings – C

	Element, % wt.											
	Fe	Si	Cu	Mn	Mg	Cr	Ni	Zn	Pb	Sn	Ti	Al
P:	0.6-1.1	10.5-13.5	0.7-1.2	0.55	0.35	0.10	0.30	0.55	0.2	0.1	0.15	Rest.
C:	0.51	11.085	0.756	0.15	0.19	0.09	0.005	0.46	0.024	0.186	0.03	

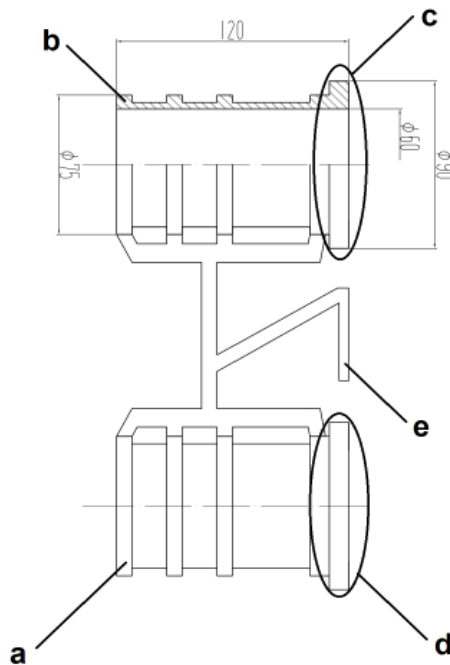

Fig. 1. Lay-out of a mould with shown location of cavities and structure of gating system: a) lower casting (L), b) upper casting (H), c) and d) places of taking samples, e) gating system

After taking some liquid metal from the melting furnace and after filling the shot chamber, temperature of the moulds cavities (140-160°C) was checked by a contactless pyrometer Raytek RAYMX2G. Stabilised temperature of cast alloy during the test cycle was within 705 to 720°C. In order to guarantee the highest quality of the castings, determined was also density index of the alloy in solid state that should be within 2.5 to 2.8 g/cm³. After realisation of the research schedule shown in Table 2, this index was contained in the required range.

TABLE 2

Setting values of valves at II and III phases and corresponding measured values of piston speed and intensification pressure

Casting designation	Value of valve opening of phase II, [%]	Piston rate, [m/s]	Value of valve opening of phase III, [%]	Intensification pressure, [bar]
A-L, A-H	0	0.2	0	0
B-L, B-H	30	0.6	0	0
C-L, C-H	30	0.6	30	80
D-L, D-H	30	0.6	80	250
E-L, E-H	70	0.8	0	0
F-L, F-H	70	0.8	30	80
G-L, G-H	70	0.8	80	250

From each of the seven series, one raw casting (Fig. 1) from the lower (L) and one from the upper (H) cavity were chosen in random way for non-destructive and destructive testing. Each of the series was marked as shown in Table 2 that includes also measured working parameters of the casting machine.

All the castings in the series A to G were evaluated with respect to irregularities observed on the casting surfaces. Total numbers of casting defects according to [9,10] in each series, subdivided to upper and lower castings, are compared in Table 3.

TABLE 3

Specification of surface defects of raw castings for each series

Casting designation	Type/Number of defects				Casting designation	Type/Number of defects			
	1):	2):	3):	4):		1):	2):	3):	4):
A-L	3	0	0	0	A-H	3	0	0	0
B-L	3	0	1	0	B-H	3	0	5	0
C-L	3	4	0	0	C-H	3	1	6	1
D-L	1	0	0	0	D-H	3	2	4	0
E-L	0	0	0	3	E-H	3	1	4	0
F-L	0	0	1	3	F-H	2	0	1	0
G-L	1	0	3	2	G-H	3	0	2	0

Defect type [10]: 1) wrinkles D 113-Al-Coq / D 114-Al-Coq; 2) surface blisters B 121-Al-Pr; 3) open shrinkage cavities B 211-Al-Sv; 4) shot marks at the gating system

On the grounds of analysis of the casting defects listed in Table 3, clear differences were found depending on working parameters of the casting machine and on positions of the castings (L or H).

X-raying of the castings at the subsequent stage revealed large quantity of shrinkage cavities and porosities in the places marked c) and d) in Fig. 1. From the marked areas, ring-shaped specimens for metallographic examinations as well as for qualitative and quantitative evaluation of casting nonconformities were cut-out. Fig. 2 shows macroscopic view of these surfaces on that gaseous blisters, porosities and numerous closed shrinkage cavities were found [9,10]. The rings cut-out from each series demonstrate a relation between the applied casting parameters, warm mould and the number of casting nonconformities in the largest cross-section of the examined sleeves. It can be seen that the number of gaseous blisters and closed shrinkage cavities visible with an unaided eye decreases with multiplication pressure from 0 (series A, B and E) to 80 bars (series C and F) and to 250 bars (series D and G). Moreover, their number is much smaller in the lower (L) than in the upper (H) castings, what Fig. 2 shows.

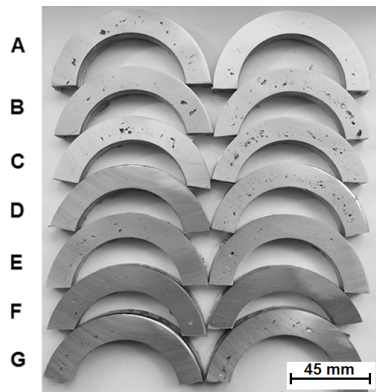

Fig. 2. Specimens in that X-ray examination revealed most numerous internal defects in form of shrinkage cavities and pinholes: lower (L) – left and upper (H) – right

3. Metallographic test results

Samples taken for metallographic test (Figs. 3-7), macrohardness measurement (Table 4) and analysis of the most important elements distribution were wet-grinded and polished using a standard sandpapers with grits from 150 to 4000. After the process of grinding and polishing, samples were observed in non-etched condition with optical microscope in magnification up to 500 \times .

Based on microstructure photographs analysis of samples with the highest amount of internal casting defects (Figs. 3 and 4) found similar dependency of their presence, as in optical evaluation of rings cut from castings (Fig. 2). Increasing the die casting machine parameters, in lower casting (L) caused casting defects such as blisters and shrinkage cavities (Figs. 2 and 3) present on the head of α -phase dendrites to distinguish in favor

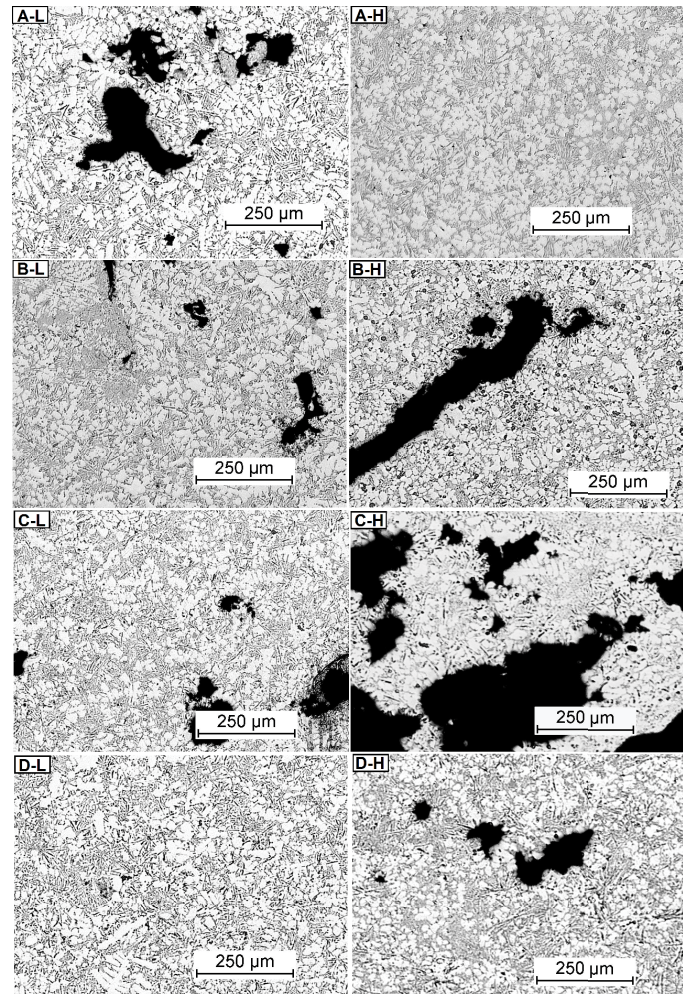

Fig. 3. View of samples' microstructure casts A-D, magnification: 50 \times , non-etched

TABLE 4

Hardness [HV] of samples taken from casts A – G

Cast	Value		Deviation		Cast	Value		Deviation	
	Min/Max	Mean	Standard	Avg.		Min/Max	Mean	Standard	Avg.
A-L	78.4/99.2	89.9	5.7	4.5	A-H	81.6/96.8	90.7	5.2	4.6
B-L	77.5/107	88.3	8.2	6.1	B-H	78.2/97.7	86	5.8	4.8
C-L	72/97.3	82	6.3	4.3	C-H	73/88.2	79.9	6.1	3.5
D-L	76/88.8	81.8	3.6	3.1	D-H	82.4/90	88	2.2	1.7
E-L	78.9/96.5	83.9	4.7	3.1	E-H	81.6/103.2	93	5.9	4.6
F-L	79.2/115.5	96.7	9.8	7.3	F-H	76.2/110.1	89.6	8.9	6.7
G-L	73.2/89.8	83.1	4.2	2.9	G-H	79/89.7	83.3	3	2.4

shrinkage microporosity visible in eutectic (α -phase + Si) and shredded shrinkage-gas microporosity (Fig. 5).

Figures 6 and 7 show microstructures of castings with indicated precipitations and possible to identify casting flaws. For comparative analysis the following series were chosen: A – B and D – G.

Samples taken from cast A made at piston speed 0.2 m/s, while cast B at 0.6 m/s, in both cases without intensifying pressure. Dendritic structure of casts A-H and B-H is specific for casts made of under eutectic alloy in gravity casting to permanent

mould. In figures of non-etch metallographic casts A-L and B-L can be seen occurring parallel to shrinkage cavities and blisters, microporosity on grain boundaries and beginning of creating silicon-rich flakes in eutectic. Samples taken from series A and B are specifying coarse-grained α -phase and noticeable iron- and copper-rich phases.

In structure in cast from series D (Fig. 7) made at piston speed 0.6 m/s and intensification pressure equaling 250 bars, observes lamellar and rosette eutectic components, which deterioration casts mechanical properties and create a specific needle-

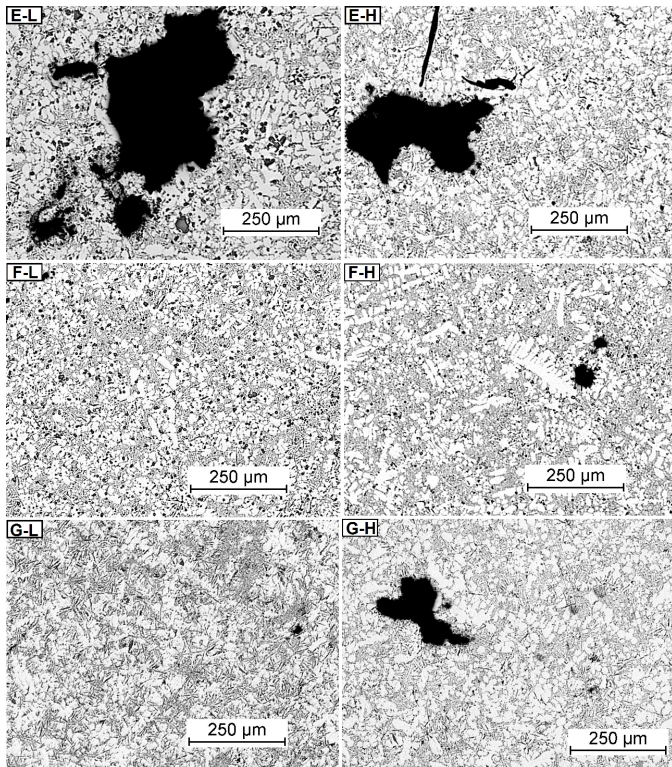

Fig. 4. View of samples' microstructure casts E-G, magnification: 50 \times , non-etched

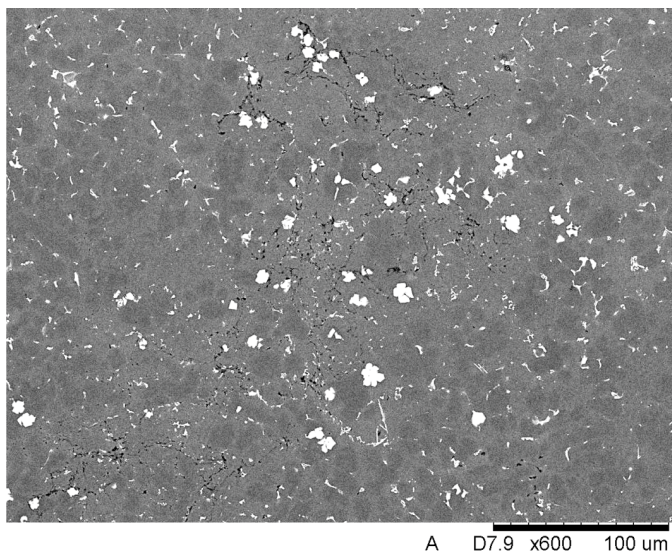

Fig. 5. View of cast F structure with shrinkage-gas microporosity, magnification: 600 \times

like microstructure. Cast G, made with extreme parameters of die casting machine, piston speed – 0.8 m/s and intensification pressure 250 bars, is similar to cast D. Lower cast G-L in comparison to upper G-H, has more fine-grained structure, numerous and therefore finer eutectic precipitator. In both cases noticed in structure presence of finer intermetallic phases made of alloying addition such as Mn, Cu and Fe.

Casts from series C, E and F have related structure to structure shown in Figures 6 and 7. Intermetallic phases, because of their size, are easily to observe in all lower casts of each seven

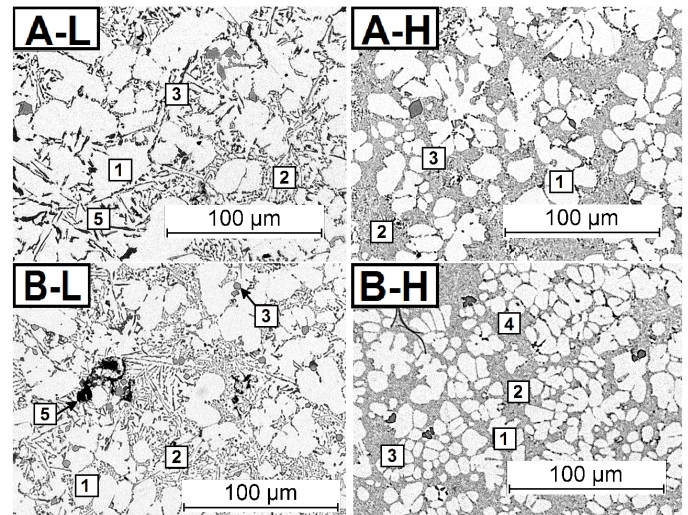

Fig. 6. Microstructures of castings A and B: 1 – phase α , 2 – eutectic mixture, 3 – iron-rich phase, 4 – copper-rich phase, 5 – shrinkage-gas microporosity. Light microscope, magnification: 200 \times , non-etched

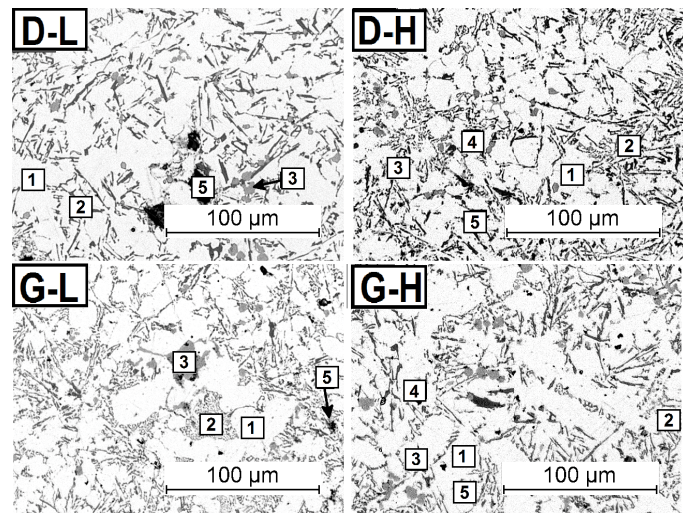

Fig. 7. Microstructures of castings D and G: 1 – phase α , 2 – eutectic mixture, 3 – iron-rich phase, 4 – copper-rich phase, 5 – shrinkage-gas microporosity. Light microscope, magnification: 200 \times , non-etched

series. Particular visible is iron-rich phase which presence with eutectic precipitation has negative effect on the mechanical properties, especially strength and hardness [11,12], of the cast material.

Hardness measurements were conducted on microhardness tester INNOVATEST 412D with parameters: load 0.981 N, dwell time 10 s. Results of ten measurements for each sample are given in TABLE 4. Measuring points were randomly chosen in various places of the analyzed metallographic sections. Nominal hardness of standardized alloy AlSi12Cu1(Fe) minimum is 70HV [13].

On the basis of macrohardness test results samples taken from all casts, it was established that hardness of upper and lower casts are above minimum value (70 HV) for that alloy. Sample taken from cast F specified in the most significant scatter of results equaling 36.3 HV. The slightest scatter of results was in

sample D-H equaling 7.6 HV. Samples taken from upper casts stood out minor deviation from mean values, what may suggest that those castings have a greater uniformity of structure.

4. Test results with using SEM analysis

On the basis of so far results, it was established that changing settings of die casting machine, despite the lack of refining process, reduce the amount of casting defects and structure of casts. Influence of pouring in extreme condition (warm mould, overheated and non-refined cast alloy, etc.) from AlSi12Cu1(Fe) alloy shown upon chemical composition analysis and present precipitation in structure in metallographic section of casts. The research was supplied in observation and evaluation of chemical composition conducted on scanning electron microscope (SEM) by Hitachi, model TM-3000.

Fig. 8 shows the analysis of the distribution of the most important elements in sample taken from cast A-L made at piston

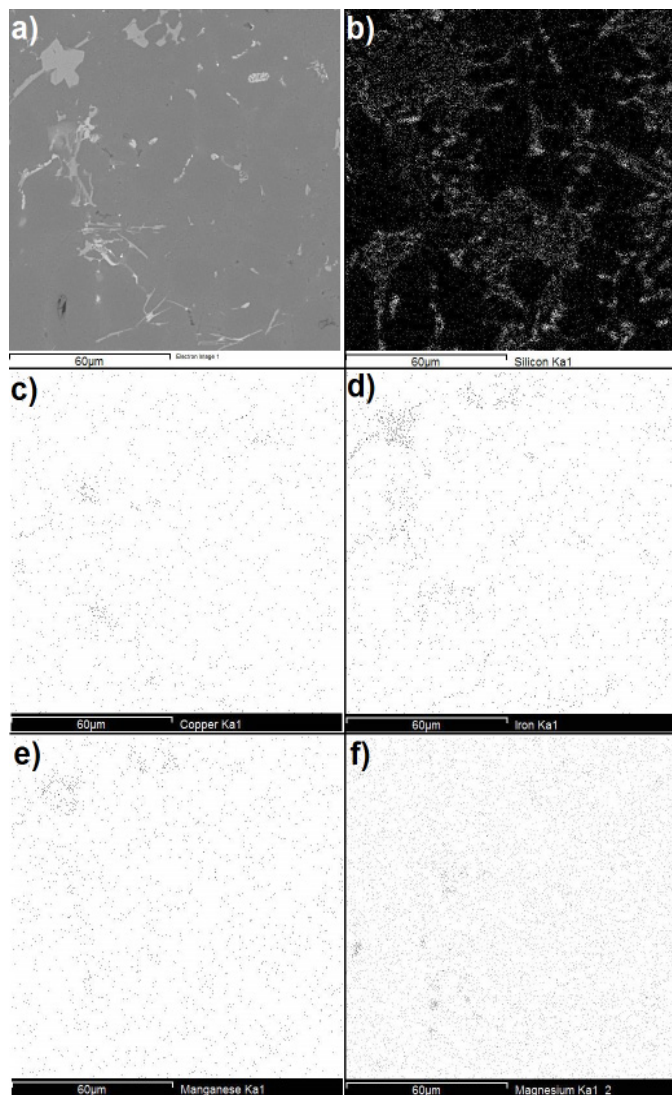

Fig. 8. Distribution of the most important elements in series: A, B and E on A-L example: a) SEM image of the structure and the distribution: b) Si, c) Cu, d) Fe, e) Mn, f) Mg; magnification: 1200×

speed 0.2 m/s and without intensification pressure, in condition similar to gravity casting method.

In the analysis of the test results of distribution of the alloying elements noticed a significant segregation of alloy addition elements in casts of series: A, B and E (Fig. 8). Considerable areas of Fe and Mn compound concentration are visible on it. Fig. 9 shows the distribution of elements in cast G, where intensification pressure was used. On the basis of chemical composition analysis of G-L cast made with increased die casting machine parameters, it was established that presence of concentrated rosette-shaped eutectic silicon pushed to the grain boundary of the fine-grained alloy structure, what explains the low hardness of the alloy. It was found that decreasing amount of clear areas of a high concentration of chemical compounds: iron with manganese and copper, which can improve the strength parameters and adjust the alloy hardness. Increasing pouring parameters were not related to distribution change of magnesium in structure alloy.

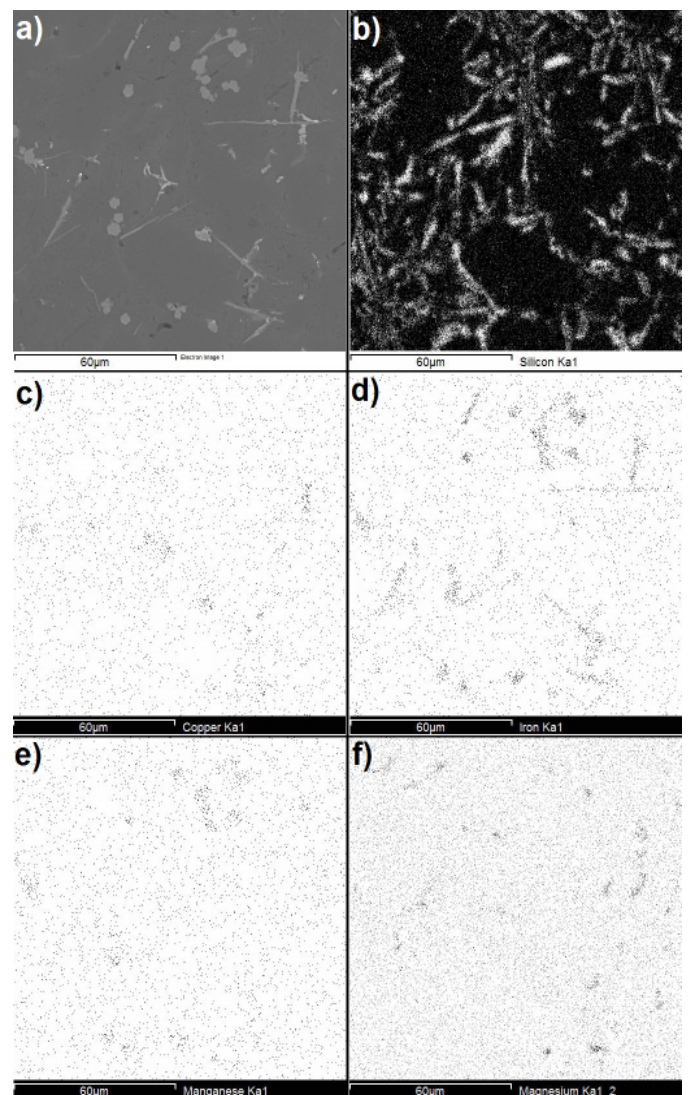

Fig. 9. Distribution of the most important elements in series: C, D, F and G on G-L example: a) SEM image of the structure and the distribution: b) Si, c) Cu, d) Fe, e) Mn, f) Mg; Magnification: 1200×

5. Conclusion

Evaluation of influence chosen die casting parameters on the alloy structure AlSi12Cu1(Fe) confirmed, that alongside with pouring speed (II phase), dispersion in alloy's structure is proceeding and it is conducive to formation of lamellar, and even rosette silicon in eutectic. Owing to using of increased intensification pressure (III phase), it can be possible to decrease amount of casting defects.

However, location of the cast above gating system (H) (Fig. 1) is less susceptible to limitation of casting flaws amount whereas speed of the II phase as well as pressure of the III phase are increased.

It was noticed, that in the case of that silumin low piston's speed can result in increasing hardness of the cast and in formation of coarse-grained structure with alloy elements separation, such as Cu, Fe, Mn and Mg in the form of hard intermetallic phases. Indirectly, it had also an influence on casting defects reduction, where they were previously present in the areas of phases precipitation with dominant intermetallic compound Fe-Mn.

On the basis of findings analysis was ascertained that two-socket symmetrical installation of the mold in the die casting machine has a significant influence on casts, which are produced using high pressure method. In this specific case, the majority of lower castings was specific of reduced amount of casting defects, while obtained microstructures are precisely connected with parameters of a die casting machine.

It was affirmed, that thanks to modernization, which was based on new control system installation with technological parameters acquisition module, it is possible to carry out an adjustment, instantaneously after finding increased numbers of surface defects, and it also enable to adapt the most appropriate die casting machine parameters to the present situation. That

settings can have a considerable influence on diminution of the prospective defects in the casts both in the case of decreasing pouring temperature, overcooled die and to the alloy's refining process exclusion.

REFERENCES

- [1] P. Dudek, A. Białobrzeski, A. Fajkel, Innovations in pressure die casting. vol. **V**, 2012 Foundry Research Institute, Kraków.
- [2] P. Dudek, A. Fajkel, T. Reguła, M. Kranc, Innovations in pressure die casting. vol. **VI**, 2013 Foundry Research Institute, Kraków.
- [3] M. Perzyk, Foundry. 2004 Wydawnictwo WNT, Warszawa.
- [4] E.A. Starke, J. Staley, Prog Aersp Sci. **32**, 131-172 (1996).
- [5] http://www.cast-alloys.com/products/lm_chart.htm
- [6] Ch. Vargel, The Advantages of Aluminium, The Metallurgy in Aluminium, in: Corrosion of Aluminium, 2004 Wydawnictwo Elsevier, Warszawa.
- [7] A.W. Orłowicz, M. Mróz, M. Tupaj, J. Betlej, F. Płoszaj, Archives of Foundry Engineering **9** (2), 35-40 (2009).
- [8] <http://stenaaluminium.com/PageFiles/6015/eng-EN%20AB-47100.pdf>
- [9] S. Kozakowski, Badania odlewów. Technologie odlewnicze, typowe dla nich wady i metody ich ujawniania. 2001 Wydawnictwo Biuro Gamma, Warszawa.
- [10] G. Henon, C. Mascré, G. Blans, Recherche de la qualite des pieces de fonderie, Polish edition, 2004 Foundry Research Institute, Kraków.
- [11] Ł. Pałyga, M. Stachowicz, K. Granat, Manufacturing Technology **16** (2), 410-416 (2016).
- [12] Ł. Pałyga, M. Stachowicz, K. Granat. Archives of Foundry Engineering **15** (2), 85-90 (2015).
- [13] http://www.steelnumber.com/en/steel_alloy_composition_eu.php?name_id=1252