

PROPERTIES OF TYPE SiMo DUCTILE IRONS AT HIGH TEMPERATURES

Ductile irons of the type of Si-Mo are characterized by increased resistance to long-term influence of high temperatures and cyclic temperature changes. They are mainly used in castings of combustion engine exhaust piping and other castings utilized at temperatures of up to 850°C. The aim of the study is to verify the mechanical properties of non-alloyed cast iron EN CSN GJS 450, SiMo4-0.5 and SiMo5-1 ductile irons at temperatures of 700 to 800°C, and the extent of their superficial oxidation after long-term annealing at a temperature of 900°C. Via chemical microanalysis the composition of oxidation products in the surface layer was evaluated.

Keywords: Si-Mo cast irons, mechanical properties at high temperatures, thermal stability of structure, oxidation resistance

1. Introduction

At operating temperatures of iron castings exceeding ca 650°C for prolonged periods there appears in-depth oxidation of the structure along graphite shapes and the metastable structure components are decomposed into stable ones. With a cyclically repeated transition of the cast iron across eutectoid temperatures A1 there occurs a transformation of ferrite into austenite and back, accompanied by repetitional volume changeovers. The transformation changes coupled with heat stress due to thermal expansion and chemical effects result in a degradation of the initial structure and a gradual appearance of thermal fatigue in the metal. The in-depth oxidation proceeds mainly along graphite shapes. Therefore the oxidation rate in ductile irons and also irons with vermicular graphite is lower than in the cast iron with lamellar graphite.

Preventing cyclic structural changes is based on thermal stabilization of ferrite up to actual operating temperatures of castings or, vice versa, on austenite stabilization over the whole temperature range so that there is no structural transformation at all. Ferrite stabilization in cast irons can be obtained in particular by increasing the silicon content to 4-6% Si while austenite can be stabilized by high nickel content [1]. Limiting the growth rate of the oxidic layer in the mostly ferritic cast irons is enhanced by the formation of compact oxides of some further elements with high affinity to oxygen, in particular chromium and aluminium, in addition to silicon. Based on cast irons alloyed in the above way, cast irons referred to as SiMo ductile irons have been developed, which have proved reliable with operating temperatures of up to ca 850°C particularly in many mass-produced automobiles.

For the highest operating temperatures at which iron castings are no longer functional, economically and technologically more demanding ferritic or austenitic steels are used.

A typical example of castings in which cyclic thermal stress appears at high temperatures can be seen in the combustion engine exhaust piping. Operating temperatures of exhaust manifold castings of serially produced automobiles are, according to the manufacturers [2], as high as 800°C by exhaust gas temperature up to 850°C. High-temperature corrosion of exhaust parts take place under intensive chemical action of the exhaust gases.

Exhaust gases mainly contain nitrogen, water vapour, oxygen, carbon oxides and lower amounts of SO_x, NO_x and compounds of HC. At low temperatures, water vapour in which exhaust gas components get dissolved in the exhaust piping condensate, with H₂SO₄ and HNO₃ being formed [3]. These products are on the one hand responsible for the direct oxidation of some elements in the cast iron, on the other hand chemically aggressive condensates of the type of nitric or sulphuric acid support intensive in-depth corrosion.

The reaction of the exhaust gases or the condensate with the exhaust piping material yields, according to the equation $x \cdot M + y \cdot O = M_x O_y$ products of oxidation reaction, which form a transition layer on the surface of the piping. The intensity of oxygen penetration into the wall depth depends on the diffusion of oxygen into the metal and, vice versa, on the diffusion of reaction products towards the surface, and also on the oxidation potential of the elements in the cast iron and on the compactness of the oxidic layer. For a given alloy and oxidation conditions, the dependence of the oxidic layer thickness on time has a roughly parabolic course.

* BRNO UNIVERSITY OF TECHNOLOGY, INSTITUT OF MECHANICAL TECHNOLOGY, FACULTY OF MECHANICAL ENGINEERING, TECHNICKÁ 2, CZ-616 69 BRNO, CZECH REPUBLIC

Corresponding author: roucka@fme.vutbr.cz

The presence of the sulphur oxides SO_2 or SO_3 increases the intensity of oxidation. The condensate formed in particular after a cold start penetrates via potential cracks in the oxidic layer into the material depth and increases the corrosion intensity. In the case of complex SiMo alloy castings there is also oxidation of other elements with high affinity to oxygen, Cr or Al in particular. From the viewpoint of protective effect it is important for the oxidic layer not to contain pores and not to peel off the base metal.

In addition to oxygen, nitrogen can also penetrate into the metal and form the Si_3N_4 or MgSiN_2 phases. The nitrides, however, do not form a continuous layer.

2. SiMo ductile irons

Materials denoted as SiMo are irons with increased content of silicon and molybdenum. They can have graphite of arbitrary shape but from the viewpoint of obtaining high mechanical properties and corrosion resistance, ductile irons, exceptionally also irons with vermicular graphite, are used almost exclusively. The content of silicon is usually increased to 4-5.5% Si, the molybdenum content is 0.5-1.5% Mo.

The high silicon content increases the temperature of eutectoid transformation A1 to values of ca 900°C or even higher [4]. Molybdenum partially segregates during solidification and forms a carbidic phase on grain boundaries. This carbidic network improves dimensional stability, increases tensile strength and creep resistance [5,6]. At the same time, however, it reduces plastic properties. Both Si and Mo increase the resistance to scale formation and thermal fatigue. The properties can be further improved via complex alloying with other elements (Ni, Cr, Al, V, and Ti), which improve the resistance to scale formation and crack formation [4]. For example, ductile iron denoted SiMo1000 [7] for use at temperatures of ca 900°C is such a complex alloyed material.

The maximum operating temperatures of exhaust manifold and the maximum temperature of exhaust gases for individual types of cast irons are approximately as given in Table 1 [3,8]. (The difference between the maximum temperatures of exhaust gases and the temperatures of exhaust manifold depends on the engine design.)

TABLE 1

Maximum operating temperatures of exhaust manifold castings of various kinds of cast iron

Exhaust manifold alloys	Maximum temperature [°C]	
	Exhaust manifold	Exhaust gases
EN-GJS 400-15	700	770
EN-GJS Si4Mo0,5	750	820
EN-GJS Si5Mo1	780	820, (870) [2]
EN-GJS SiMoNi	795	835
Niresist D-5S	870	950

2.1. Recommended composition and structure of basic types of SiMo ductile irons

Type SiMo ductile irons are defined in the EN CSN 16124 Standard [9]. This directive specifies the range of Si and Mo contents, requirements for the structure, and the standard deviations of mechanical properties at ambient temperature. Informative appendices of this standard give tentatively the values of some mechanical and physical properties under increased temperatures. Regarded as the basic alloys of this type are the ductile irons EN-GJS-SiMo40-6 and EN-GJS-SiMo50-10 with content of silicon and molybdenum:

EN-GJS-SiMo40-6: 3.8-4.2% Si, 0.5-0.7% Mo

EN-GJS-SiMo50-10: 4.8-5.2% Si, 0.8-1.1% Mo

- The carbon content should be chosen with a view to the silicon content such that the iron has the carbon equivalent C_E in the interval from 4.6 to 4.8 ($C_E = C + 1/3 \text{ Si}$) [2],
- Mn content not prescribed, usually <0.3% Mn,
- The content of the other elements is the manufacturer's choice,
- Structure: a minimum of 85% of ferrite, a maximum of 5% of carbides of the type of Fe_2MoC or $\text{Fe}_2\text{MoC}/\text{M}_6\text{C}$, and the rest is pearlite [2,4],
- Graphite – recommended dispersity: a minimum of 100 nodules/ mm^2 [2].

The tendencies in the effect of silicon and molybdenum on structure and properties given in [6,7] are also confirmed by Ekström [10].

2.2. Corrosion resistance of SiMo ductile irons

Using the Thermo-Calc program, the composition and phase proportion in the transition layer in SiMo ductile irons were established. It was found that in the direction from the surface into the manifold wall the transition layer was successively formed by the Fe_2O_3 phase, deeper in the wall by Fe_3O_4 , then by $\text{FeO}+\text{Fe}_2\text{SiO}_4$ and a thin layer of $\beta\text{-SiO}_2$ separating the band of oxides from the base metal – Fig. 1. The SiO_2 layer was more compact than the ferrous oxides and represented the most significant barrier to oxygen diffusion [10]. If the alloy contains chromium, the layer of Cr_2O_3 oxides formed in the region of SiO_2 layer reduces the speed of oxidation very significantly.

3. Experimental verification of the effect of silicon and molybdenum alloying on the structure and mechanical properties

Since the strength of cast irons under temperatures corresponding to actual temperatures in exhaust manifold decreases dramatically in comparison with the strengths under normal temperatures, experimental testing of mechanical properties was

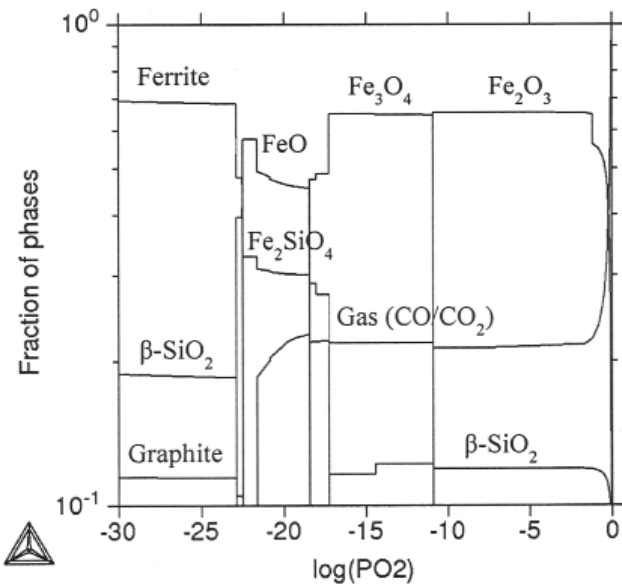

Fig. 1. Composition of oxidic phases in the surface layer as calculated by Thermo-Calc [10]

performed for two alloys of the SiMo type corresponding to the SiMo4-0.5 and SiMo5-1 specifications, and for the basic non-alloyed ductile cast iron corresponding to the material according to EN-CSN GJS 450 by ambient temperature and temperatures of 700 and 800°C.

Resistance to oxidation was tested on specimens prepared from these cast irons, under long-term annealing at a temperature of 900°C.

3.1. Alloys under examination and specimen casting

Melting was performed in the BUT foundry in an induction furnace with 80 kg crucible capacity. The base alloy charge was made up of 45% of raw iron, 20% of steel, 35% of GJS scrap, FeSi70 and FeMo65.

Modification – 0.8% Elmag 5800, inoculation with 0.5% FeSi70, using the tundish ladle.

Modification temperature – 1530°C.

The resultant chemical composition of the tested cast irons is given in Table 2

TABLE 2

Chemical composition of the tested cast irons

Cast iron	C	Si	Mn	Mo	Cr	S	P
GJS 450	3.35	2.52	0.22	0	0.075	0.021	0.049
SiMo 4-0.5	3.25	3.50	0.26	0.54	0.039	0.021	0.039
SiMo 5-1	3.2	5.24	0.25	1.02	0.062	0.024	0.050

Test specimens of the above alloys were cast in the shape of plates 20 mm thick, with thickened lateral edges for the purpose of metal feeding during solidification and thermal homogenization of the plates during solidification used by Ekström [10]. The moulds were made of a self-setting moulding mixture using

the Alphaset method. The plate edges were cut off as shown in Fig. 2. The centre part of the plate was used to make mechanical test specimens and specimens for structure analysis.

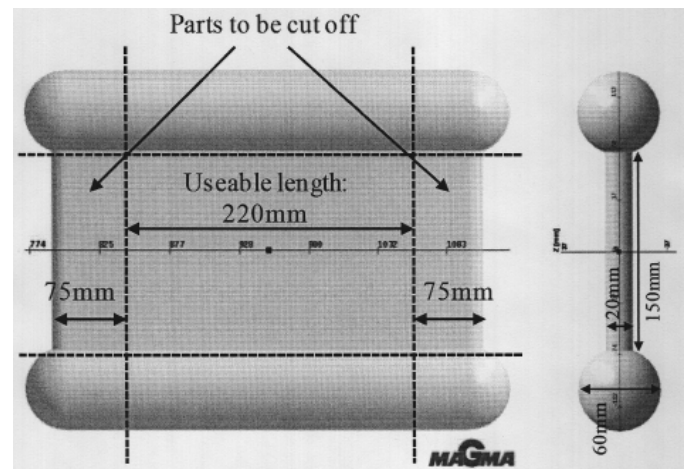

Fig. 2. Test-plate casting

3.2. Mechanical properties testing

In tensile tests, cylindrical test specimens with threaded heads according to the standards CSN ISO 6892-1 and 2 were used, diameter $d_o = 5.5$ mm, measured length 40 mm. The tests were performed using the methodology given in these standards. Hardness was measured on the heads of tensile test specimens.

The following properties were tested:

- tensile strength at normal temperature and at temperatures of 700 and 800°C, yield point, elongation and contraction values,
- HB hardness at normal temperature.

The values of mechanical properties given in Table 3 are an average of 4 measurements, the hardness values an average of 3 measurements.

TABLE 3

Mechanical properties of cast irons

Temperature [°C]	Alloy	R_m [MPa]	s	$R_{p0.2}$ [MPa]	s	A_5 [%]	s	HB
20	GJS 450	497	4.3	354	6.7	14.2	0.7	161
	SiMo 4-0,5	582	6.5	483	7.9	8.3	2.9	
	SiMo 5-1	610	17.3	595	6.0	0.7	0.3	
700	GJS 450	91.4	3.1			34.5	8.2	239
	SiMo 4-0,5	107.7	2.2			41.2	7.8	
	SiMo 5-1	118.7	3.7			22.7	4.6	
800	GJS 450	46.2	2.5			44.6	8.9	236
	SiMo 4-0,5	49.8	3.0			48.8	7.8	
	SiMo 5-1	53.4	1.9			33.9	4.6	

Note: The tensile curves for elevated temperatures have a course from which the device software does not evaluate the value $R_{p0.2}$ – Fig. 3. The tensile curves for the temperatures 700 and 800°C have a similar course.

The values of strength R_m and elongation A are given in Figs 4 and 5. (The connecting line of the curves between the

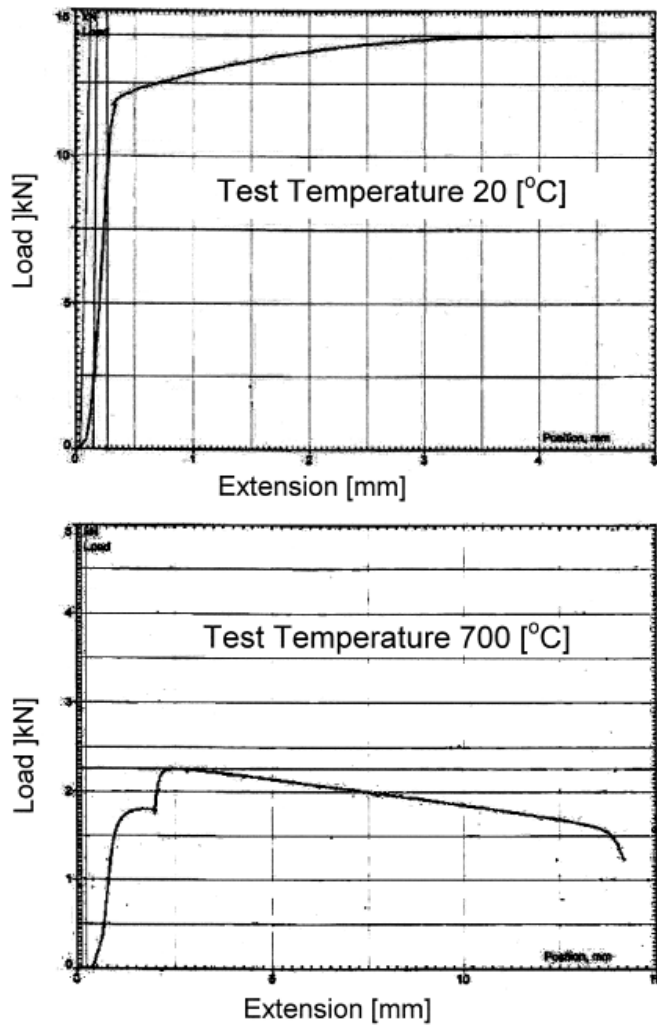

Fig. 3. Tensile strength diagrams for the temperatures 20°C and 700 (800)°C

temperatures 20 and 700°C is not real, it is only given for the sake of clarity.) It is obvious that in static tests the cast iron strengths in the range of operating temperatures are markedly lower than at the normal temperature. At elevated temperatures the elongation increases significantly.

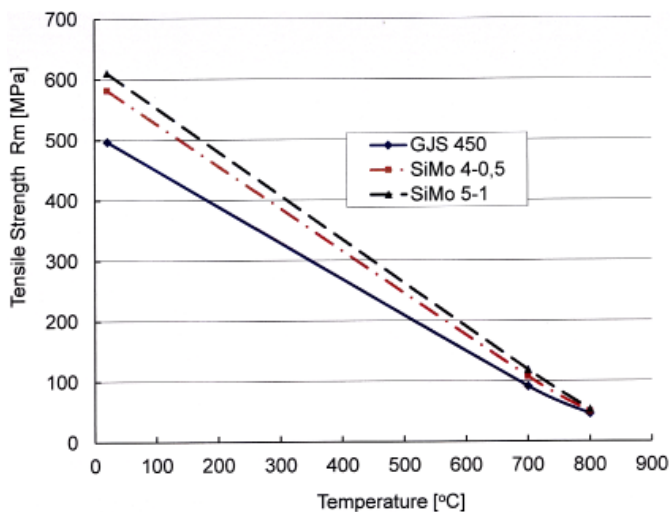

Fig. 4. Effect of temperature on tensile strength

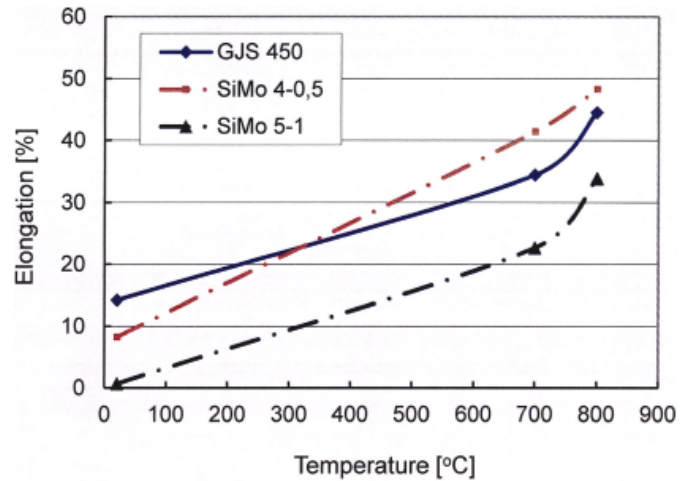

Fig. 5. Effect of temperature on elongation

3.3. Structure analysis

3.3.1. Structure analysis of irons as cast

Metallographic optical analysis was performed on specimens of cast irons as cast, Fig. 6. The subject of evaluation was the graphite size and the pearlite content in the structure. Graphite in all the cast irons was spheroidal and its share was >95%.

The structure of the base metal in the as-cast state was ferritic-pearlitic in the basic non-alloyed cast iron while in the SiMo ductile irons it was ferritic with pearlite and carbide content of up to 10-15%.

3.3.2. Effect of annealing on the formation of surface oxidic layer

The effect of long-term action of high temperatures on the cast irons under examination was simulated via annealing the specimens in an electric resistance furnace at a temperature of 900°C for a period of 72 hours in calm-air environment. After annealing, the specimens were cut transversely. The structure of the surface oxidic layer was evaluated on a Philips XL 30 electron microscope, and selected points on the cross-section of layers were chemical microanalysis performed.

Fig. 7 shows the oxidized layer on the basic cast iron, with the analysed points marked 4 and 5, and with the area of thin contact layer between the oxidic layer and the base metal – see the detail A, points 1-3. It is obvious from the chemical analysis given in Table 4 that the highest oxygen and silicon content in this zone was analysed which indicates the formation of a barrier of SiO₂.

In the two SiMo ductile irons the Si content near the specimen surface, point 3 is very low or even zero, in the central part it is somewhat higher than indicated by the average chemical composition – see Fig. 8, point 2. The Si content on the contact between oxides and the base metal is substantially increased and high content of chromium and manganese were analysed

TABLE 4

Chemical composition and thickness of oxidic layer after annealing 900°C-72 h

Spot		Fe	O	Si	Cr	Mn	Layer thickness [mm]
EN GJS 450							
1	metal	92.0	5.3	2.4	—	—	0.4-0.6
2	metal-oxid	56.8	34.9	8.3	—	—	
3	oxid	66.0	30.1	3.9	—	—	
4	oxid	68.1	28.3	3.6	—	—	
5	oxid-gas	70.8	28.9	0.8	—	—	
SiMo 4-0.5							
1	metal-oxid	36.8	36.3	16.0	3.95	6.95	0.2-0.3
2	oxid	63.5	31.3	5.3	—	—	
3	oxid-gas	68.8	31.2	0	—	—	
SiMo 5-1							
1	metal-oxid	31.3	39.1	19.8	6.41	3.48	0.1-0.2
2	oxid	59.3	37.7	6.9	—	1.08	
3	oxid-gas	69.1	31.0	—	—	—	

4. Results and discussion

The mechanical properties tests performed have confirmed that the tensile strength values at temperatures that actually correspond to the operating temperatures of exhaust piping are in all the cast irons evaluated markedly lower than at the normal temperature. At a temperature of 700°C they attain approximately 20% of the strength value for the ambient temperature, at 800°C only 10% of the strength at ambient temperature. Under the high temperatures given above, all the cast irons exhibit plastic behaviour, with the elongation values increasing considerably. In all the test modes the SiMo5-1 ductile irons display the highest tensile strength and the lowest elongation. It is obvious from these results that for a proper dimensioning of castings working under such high temperatures it is necessary to respect the mechanical properties that actually hold for a given operating mode.

The evaluation of the oxidic layer after annealing to 900°C has confirmed a pronounced protective effect of the alloying elements silicon and molybdenum on the oxidation extent. The SiMo5-1 ductile iron is substantially more resistant to oxidation than the SiMo4-0.5 ductile iron. The oxidic layer thickness in the SiMo4-0.5 ductile iron is roughly half this thickness in non-alloyed cast iron GJS 450 while in the SiMo5-1 ductile iron it is approximately one quarter. The chemical microanalysis has shown that the barrier to the oxidation advance into the metal depth consists in a thin layer of silicon oxide (probably β -SiO₂), which is formed at the oxidic layer/base metal interface. This layer also contains a considerable amount of chromium, which was contained in the basic cast iron in only trace amounts. The chromium oxides obviously participate in the barrier effect of the silicon oxide. The outer parts of the oxidic layer are mostly formed by ferrous oxides. The results obtained are in good

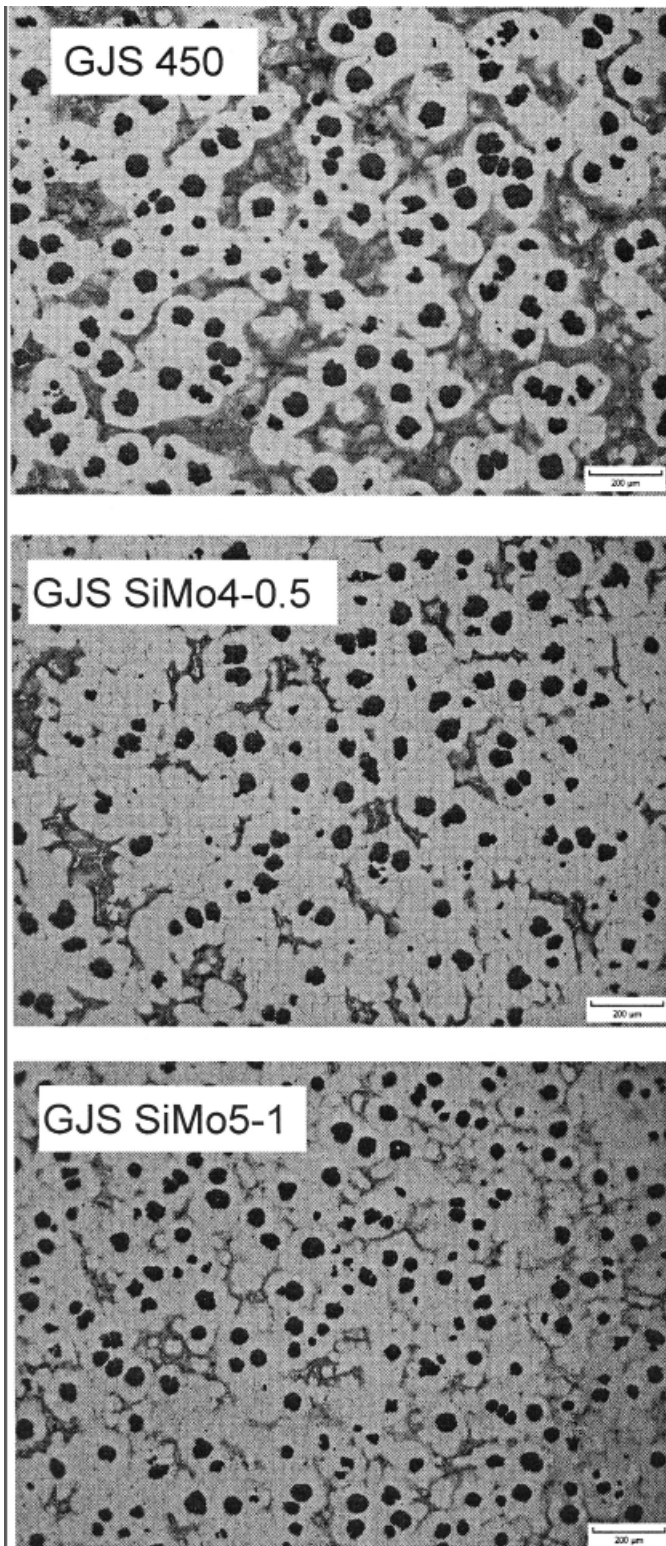

Fig. 6. Structures of as-cast irons

there, which participates on creating the protective barrier. This elements were in outward oxide layer not detected. With the SiMo5-1 ductile iron the situation is similar, Fig. 9.

In the SiMo ductile irons the average oxidic layer thickness decreases significantly in comparison with non-alloyed GJS while in the higher-alloyed SiMo5-1 ductile iron the thickness of oxidic layer is again considerably lower than in the SiMo4-0.5, see Table 4.

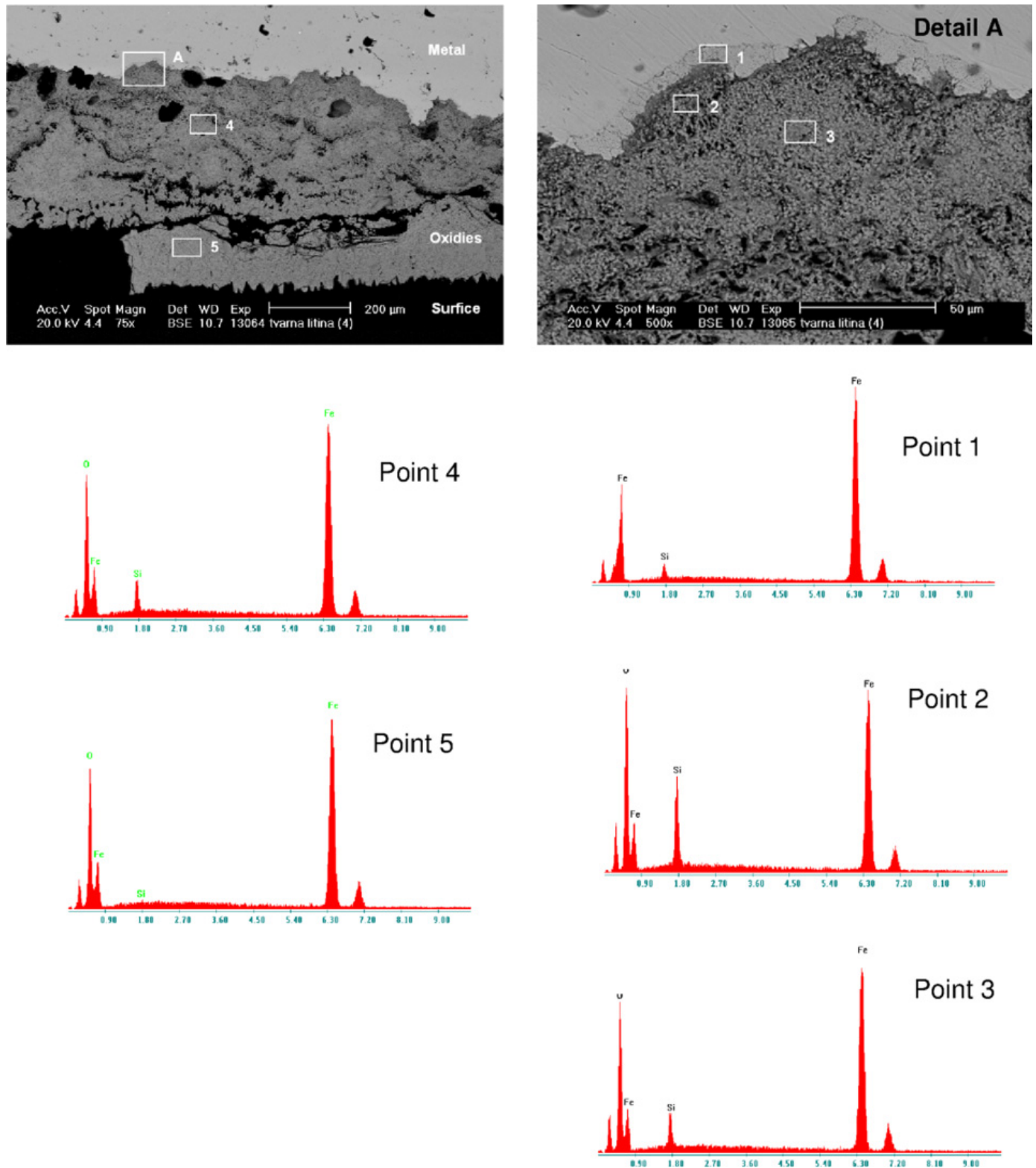

Fig. 7. Structure of oxidic layer on GJS-450 iron

agreement with the computation results from the Thermocalc program (without influence of Cr content).

The test conditions do not reflect the actual situation during the cyclic thermal stress of exhaust piping, the adhesion of oxidic layer to the base metal or the chemical effect in corrosion caused by actual exhaust gases. These effects can only be established when testing under operating conditions.

Acknowledgement

This investigation was realised under support of the project of BUT-FME CZ-Brno, Nr. FSI-S-16-3686

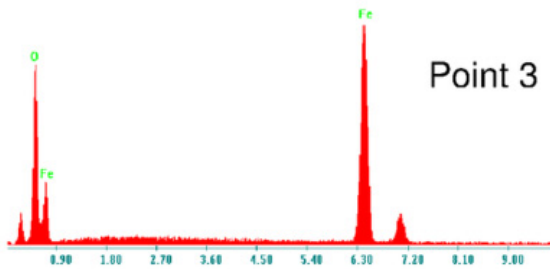
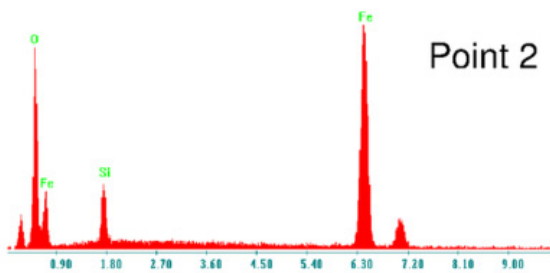
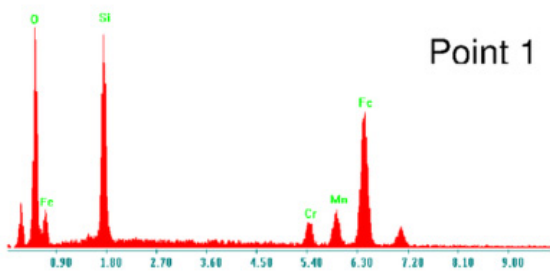
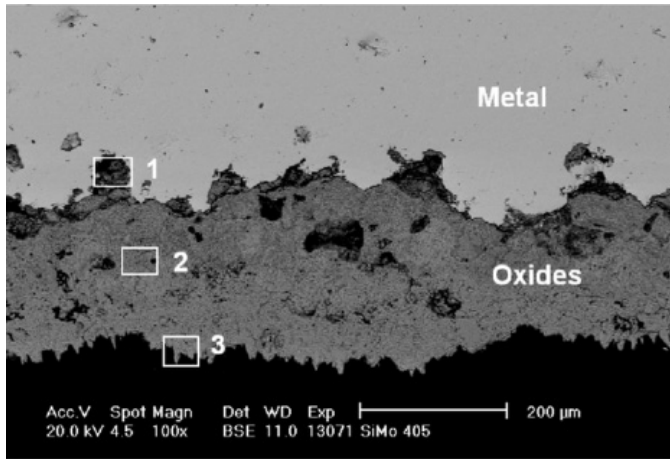

Fig. 8. Structure of oxidic layer on SiMo4-0.5 iron

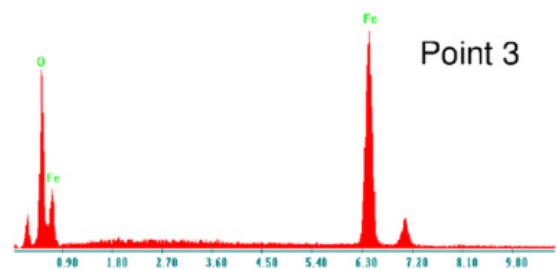
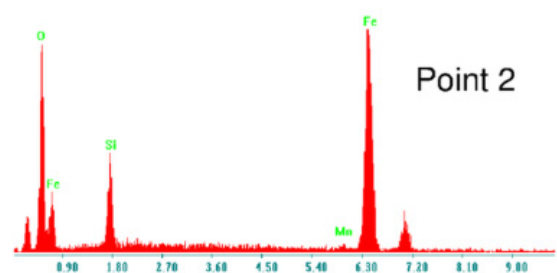
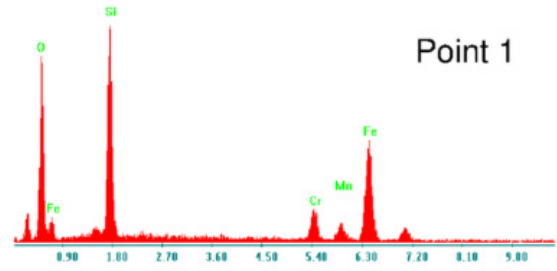
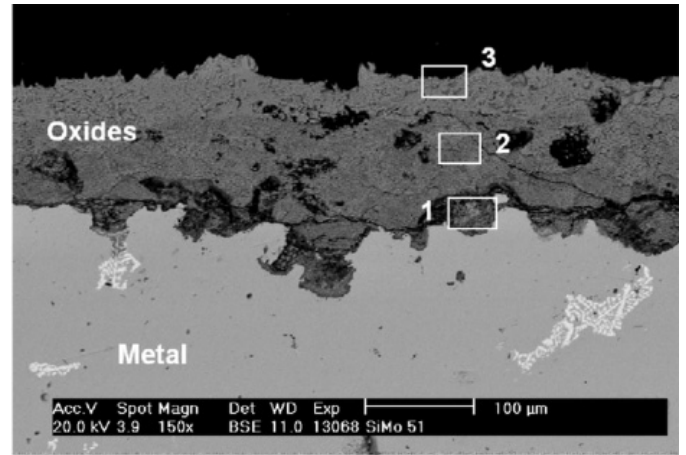

Fig. 9. Structure of oxidic layer on SiMo5-1 iron

REFERENCES

- [1] W. Fairhurst, K. Röhrig, Foundry Trade Journal **152**, 62-64 (1979).
- [2] D.J. Wirth, Modern Casting **88**, 12-18 (1998).
- [3] F. Tholence, M. Novell, Oxid. Met. **69**, 13-36 (2008).
- [4] K.J. Papis, S. Tunzini, W. Menk, G. Fischer, Livarski Vestnik **62**, 2-16 (2015).
- [5] L.M. Aberg, C. Hartung, Trans. Indian Inst. Met. **65**, 633-636 (2012).
- [6] P. Matteis, G. Scavino, A. Castello, D. Firrao, Procedia Materials Science **3**, 2154-2159 (2014).
- [7] European patent EP 1 386 976, 2003.
- [8] <http://www.wmlee.co.uk/manufacturing/material/SiMo>.
- [9] ČSN EN 16124, Slévárenství – Nízkoalokovaná feritická litina s kuličkovým grafitem pro použití za zvýšených teplot, 2012.
- [10] M. Ekström, Development of a Feritic Ductile Cast Iron for Increased Life in Exhaust Applications, PhD thesis, KTH Royal Institute of Technology, Stockholm, 2013.