

Z. PATER*, J. TOMCZAK*

EXPERIMENTAL TESTS FOR CROSS WEDGE ROLLING OF FORGINGS MADE FROM NON-FERROUS METAL ALLOYS

PRÓBY DOŚWIADCZALNE WALCOWANIA POPRZECZNO-KLINOWEGO ODKUWEK ZE STOPÓW METALI NIEŻELAZNYCH

Reported in this paper are the experimental test results for hot cross wedge rolling of elementary shaft forgings made from light metal alloys which are widely used in aviation industry, such as aluminum alloys 6101A and 2618A, titanium alloy Ti6Al4V as well as magnesium alloys AZ31 (Mg 3Al-1Zn-Mn), AZ61 (Mg 6Al-1Zn-Mn) and Mg4AlZnMn. The research works were conducted by means of a flat-wedge rolling mill LUW-2, with typical wedge tools used. The experiment tests involved the analysis of force parameters, geometrical parameters, and process stability. The conducted experimental tests prove the feasibility of forming axially symmetric parts made from light metal alloys in CWR (cross wedge rolling) processes. Limitations upon the application of CWR technologies to forming such alloys are also described.

Keywords: cross-wedge rolling, aluminum alloys, titanium alloys, magnesium alloys

W pracy przedstawiono wyniki doświadczalnych prób walcowania poprzeczno-klinowego (WPK) na gorąco odkuwek elementarnego wałka ze stopów metali lekkich: aluminium w gatunkach 6101A i 2618A; tytanu w gatunku Ti6Al4V oraz magnezu w gatunkach AZ31 (Mg 3Al-1Zn-Mn), AZ61 (Mg 6Al-1Zn-Mn) i Mg4AlZnMn, które są powszechnie stosowane w przemyśle lotniczym. Badania przeprowadzono na płasko-klinowej walcierce laboratoryjnej LUW-2, wykorzystując typowe narzędzia klinowe. W trakcie eksperymentu analizowano parametry siłowe, geometryczne oraz stabilność procesu. W efekcie przeprowadzonych doświadczeń potwierdzono możliwość kształtowania wyrobów osiowo-symetrycznych ze stopów metali lekkich w procesach WPK. Określono również ograniczenia w stosowaniu technik WPK do kształtowania tych stopów.

1. Introduction

Light metals, the most numerous group of which are aluminum, magnesium and titanium alloys, are widely used in aerospace and automotive industries. Their small density combined with relatively high strength properties make these alloys widely applied to production of lightweight parts. Light metal alloys (aluminum, titanium, and magnesium alloys) are additionally characterized by their favorable construction parameters namely, their strength to specific gravity ratio which is higher than for steel [1]. Owing to that a significant decrease in the total machine weight can be obtained, with high strength and construction parameters being retained. It is estimated that over 60% of aircraft construction is made from aluminum alloys, while the use of titanium and magnesium alloys in manufacturing such parts amounts to 20% and 10% respectively. Given the decrease in construction weight, maintenance costs can be decreased as well.

At present, aluminum alloy parts are predominantly manufactured by means of machining and casting technologies. The machining process involves a high machine load and a relatively small material yield, which, combined with high material costs, renders the process particularly unfavorable. Manufacturing parts made from light metal alloys by means of casting allows for forming of even very complex products. Nonetheless, due to fast oxidation of such alloys, it is necessary to employ protective atmospheres during metal melting and casting. In addition to that, titanium alloys are characterized by a very high melting temperature. Consequently, casting processes are difficult and very expensive to conduct. The obtained cast structures have to be segregated, which negatively affects strength properties of such elements. In effect, more and more attention is given to the application of metal forming processes to manufacturing parts made from light metal alloys with high strength properties. Such materials as aluminum, magnesium, and particularly titanium alloys are hard to deform, which is

* LUBLIN UNIVERSITY OF TECHNOLOGY, 20-618 LUBLIN, 36 NADBYSTRZYCKA STR., POLAND

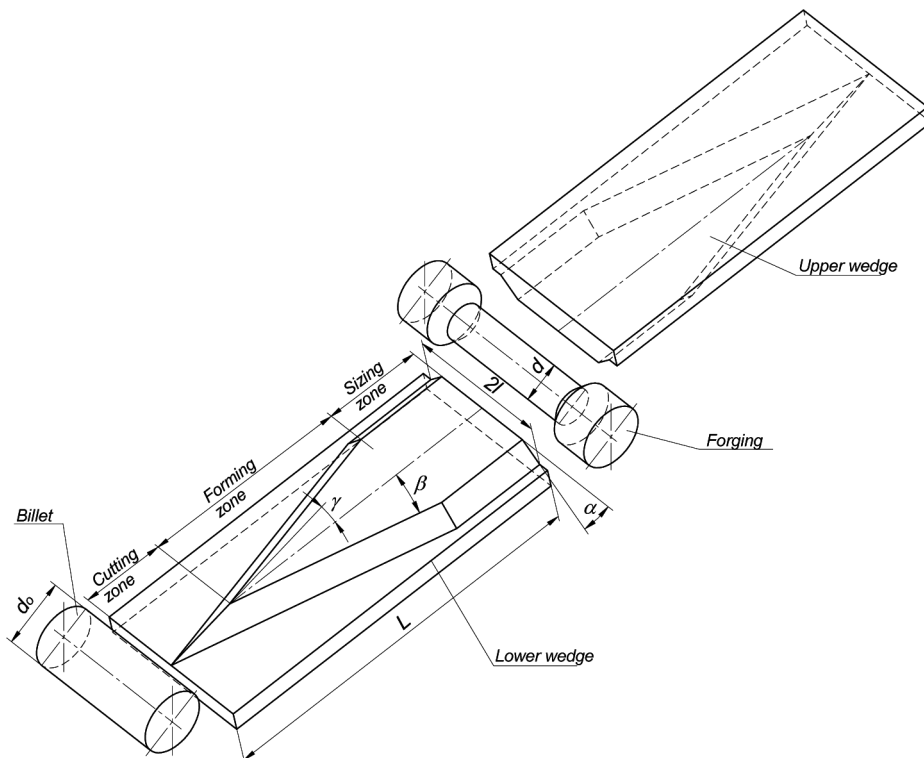

Fig. 1. Scheme of the cross wedge rolling process, where the main geometrical parameters of the tools and the rolled forging are marked

the main reason for a rare use of metal forming processes to form these materials. Yet due to a number of beneficial qualities of products obtained with metal forming methods, like lesser material use and their considerably higher strength properties due to favorable structure formation, it is justified to search for new methods allowing for producing elements by means of metal forming technologies.

The Department of Metal Forming and Computer Modeling at Lublin University of Technology has been making intensive research into cross wedge rolling (CWR) processes for a number of years. Recently, tests for the cross wedge rolling process of axially symmetric products made from aluminum, magnesium and titanium alloys have been made. A scheme of producing an elementary shaft in cross wedge rolling with flat tools is illustrated in Fig. 1.

Cross wedge rolling processes are characterized by a number of advantages, the most important of which include high efficiency, better material use, enhanced strength properties, environment protection, lower energy consumption, automation possibility, and low production costs [2]. Owing to that, the CWR method has been widely used in predominantly machine industry for producing steel elongated forgings such as stepped axles and shafts [3-6]. The CWR process is often used for producing preforms used in die forging of such products as keys, connecting rods, levers, forks, and bike

pedal cranks [7, 8]. Other products obtained with this method include: high voltage insulator cores [9], forgings of parts used in automotive industry (steering gear pins, suspension parts, etc.) [10], rotary cutters [11] and screw spikes [12].

2. Scope of the conducted experimental tests

In order to prove the feasibility of applying the process of cross wedge rolling to manufacturing products made from light metal alloys and to determine the factors limiting the forming process, a number of experimental tests of hot rolling for an elementary shaft made from aluminum, titanium and magnesium alloys were conducted. For the test purposes, alloys suited for metal forming which are widely employed in aviation industry were used. The used aluminum alloys included two material types: 6101A (EN AW-AlMgSi) and 2618A (EN AW-AlCu2Mg1.5Ni). To roll forgings made from titanium alloys, type Ti6Al4V was used. Magnesium alloy forgings were formed out of three different material types: AZ31 (Mg3Al1ZnMn), AZ61 (Mg6Al1ZnMn) and Mg4AlZnMn. Both markings and strength properties of the used materials are presented in Table 1.

The experimental tests have been conducted on a laboratory flat-wedge rolling mill LUW – 2, which is a part of the equipment used in the Department of Metal Forming and Computer Modeling at Lublin University of

Technology. To conduct the tests, three sets of flat-wedge tool segments (Fig. 2a) mounted in specially designed mounts (Fig. 2b) and fixed to the rolling mill slides were used. The deformation ratio value $\delta = d_o/d$ was adjusted

by means of special pads placed in the mounts under the wedge segments.

TABLE 1

Comparison of physical and mechanical properties of the analyzed light metal alloys [13-17]

Marking according to PN	Marking according to EN	$R_{0,2}$ [MPa]	R_m [MPa]	A_5 [%]	HB	ρ [g/cm ³]
6101A	AlMgSi	>140	>180	16	60	2,7
2618A	AlCu2Mg1,5Ni	>310	>390	9	105	2,85
Ti6Al4V		>780	>860	8-10	305	4,5
AZ31	Mg3Al1ZnMn	200	265	13	49	1,75
AZ61	Mg6Al1ZnMn	230	310	15	60	1,8
	Mg4AlZnMn	180	280	10	52	1,78

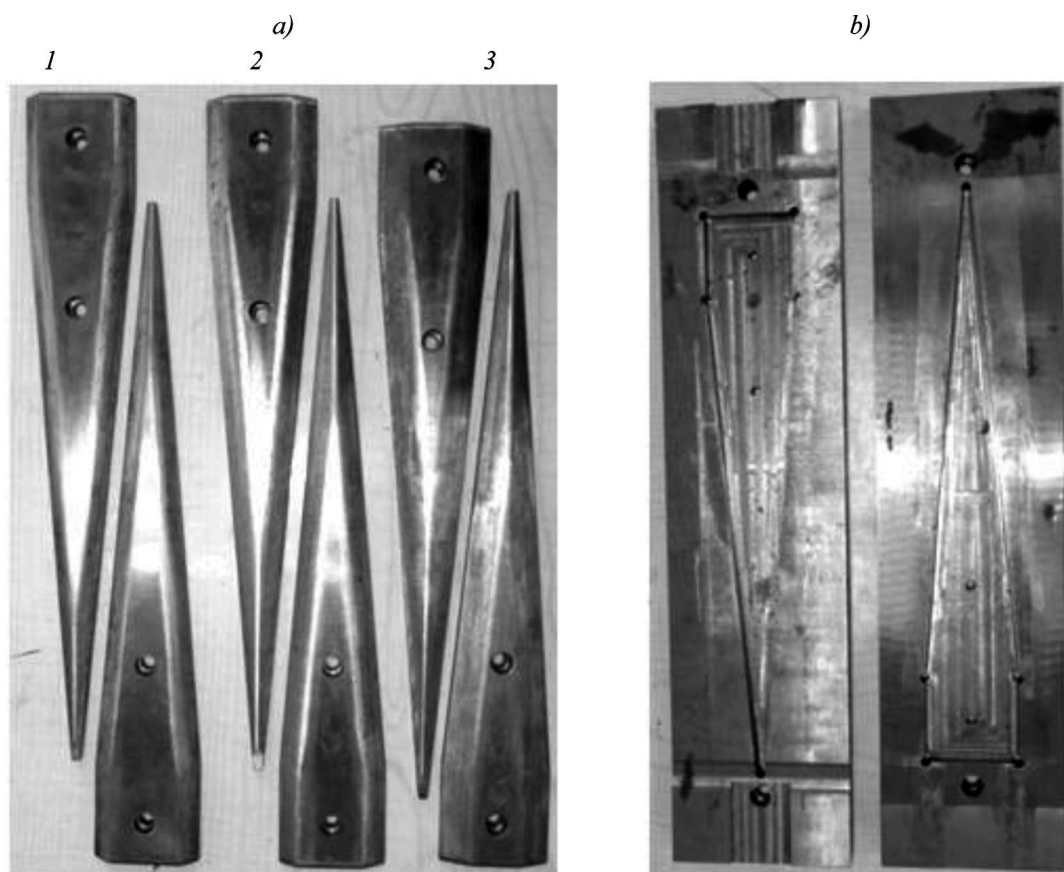

Fig. 2. Tools used in the CWR experimental tests for light metal alloys: a) wedge sets (1 - $\alpha = 25^\circ$, 2 - $\alpha = 32.5^\circ$, 3 - $\alpha = 40^\circ$), b) wedge mounts

TABLE 2

Comparison of process parameters and tool geometrical parameters in the CWR process for light metal alloys used in the experimental tests

Item no.	Material						Spreading angle	Forming angle	Deformation ratio	Billet diameter	Rolled step diameter			
	6101A	2618A	Ti6Al4V	AZ31	Az61	Mg4AlZnMn	β [°]	α [°]	δ	d_o [mm]	d [mm]			
	Billet temperature [°C]													
1	450	450	960	400	400	400	7	25	1.875	30	16			
2									1.5		20			
3									1.25		24			
4							7	32.5	1.87	30	16			
5									1.67		18			
6									1.5		20			
7									1.36		22			
8									1.25		24			
9									7		40	1.875	30	16
10												1.5		20
11							1.25	24						

The use of flat-wedge tools allowed for rolling of semi-finished products at the constant wedge spreading angle value $\beta = 5^\circ$ and at three different values of the forming angle α , which, respectively, were as follows: 25° , 32.5° and 40° . Table 2 presents a comparison of the process parameters as well as geometrical parameters of the tools used in the tests. The rolling tests were conducted in hot conditions, with the billet heated up in a chamber furnace. The used semi-product (the billet) were bars whose diameter $d_o = 30$ mm and length $l = 60$ mm. The wedge velocity value was of 0.125 m/s.

3. Experimental test results

The main purpose of the conducted experimental research was to prove whether the forgings made from

non-ferrous metal alloys could be formed with CWR methods and to determine those areas where the rolling process proceeds in a stable manner. During the experimental tests, force parameters, process stability, and geometrical parameters of the obtained products were analyzed.

Sample forgings of the elementary shaft made from aluminum alloys 6101A and 2618A formed in the CWR process, where $\alpha = 32.5^\circ$, $\beta = 5^\circ$ and the deformation ratio ranged from $\delta = 1.25$ to $\delta = 1.875$ are shown in Fig. 3.

Analyzing the shape of the obtained products, it was observed that what affects significantly the quality and accuracy of the forgings are such parameters as the deformation ratio value, tool segment angles as well as the kind of the rolled material (aluminum alloy type).

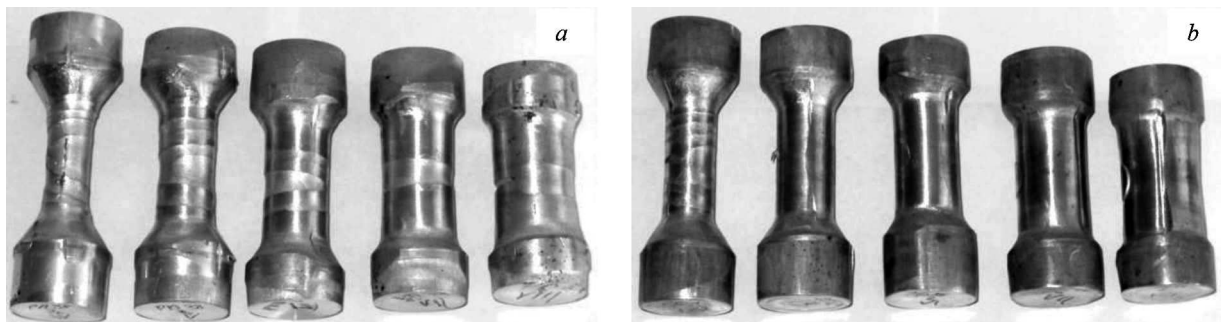

Fig. 3. Forgings obtained in the CWR process of alloy: a) 6101A b) 2618A Tool parameters: $\alpha = 32.5^\circ$, $\beta = 5^\circ$. Deformation ratios: respectively from the left $\delta = 1.875$, $\delta = 1.67$, $\delta = 1.5$, $\delta = 1.36$, $\delta = 1.25$

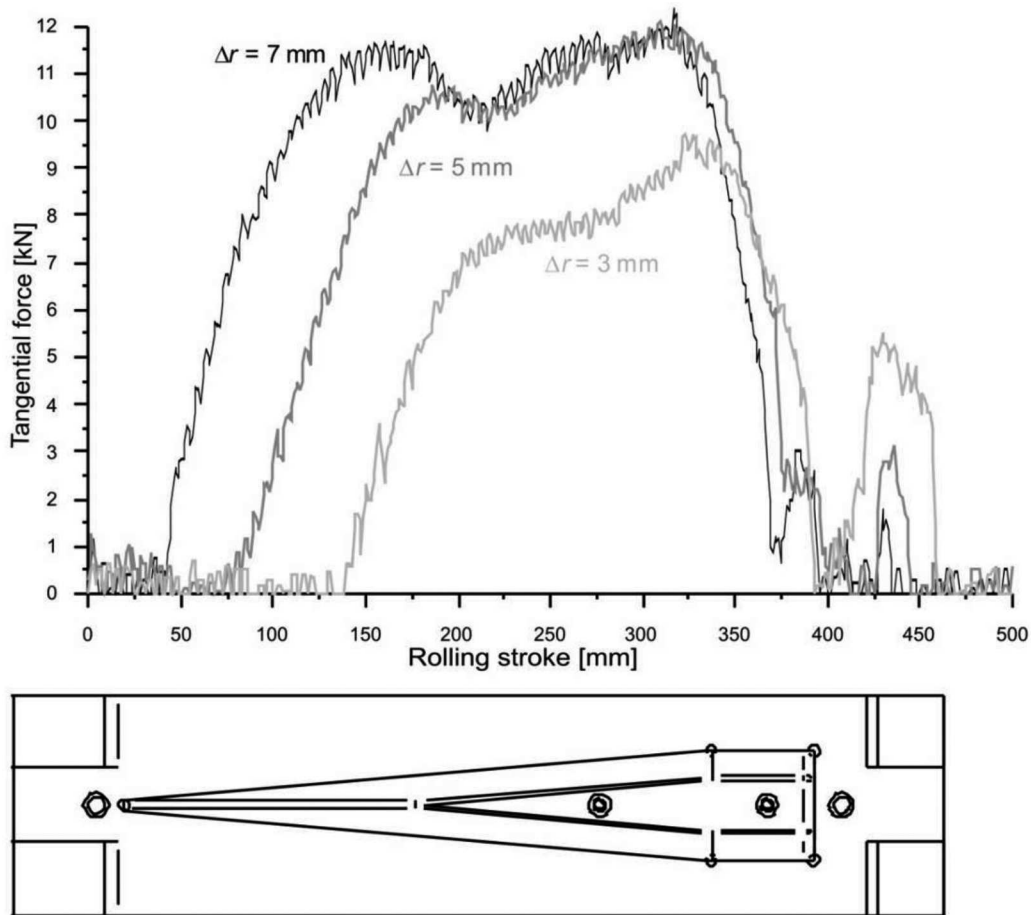

Fig. 4. Distributions of forming forces observed in CWR of forgings made from alloy 6101A conducted at different values of the deformation ratio δ , the other parameters being: $\alpha = 25^\circ$, $\beta = 5^\circ$, $T = 450^\circ\text{C}$, $v = 0.125$ m/s

While rolling a more plastic alloy (6101A), it was observed that screw grooves appeared on the surface of the rolled step and their depth increased together with an increase in the deformation ratio. The observed spiral grooves are relatively shallow in the case of products rolled with tool segments at low forming angle values; furthermore, the grooves disappear as the deformation ratio gets lower. Formed at the same geometrical parameters, forgings made from aluminum alloy 2618A with better strength properties do not have such defects, and the spiral grooves appear only at larger deformation ratio values ($\delta \geq 1.875$) and at increased forming angle values ($\alpha \geq 32.5^\circ$). These grooves are, however, considerably less deep when compared to the ones observed on the forgings rolled from alloy 6101A. Additionally, the forgings rolled from alloy 6101A at maximum deformation ratios ($\delta = 1.875$) have neck formed on the rolled step, which leads to billet necking. Such limitation was not observed in rolling of alloy 2618A, whose deformation ratio had the value of $\delta = 1.875$. The accuracy of both shape and measurements of aluminum alloy products formed in CWR is significant. The observed deviations

are within the range of ± 0.1 mm for alloy 2618A and ± 0.3 for alloy 6101A. Also, their surface quality and smoothness are very high, especially in the case of shafts rolled from alloy 2618A, whose surface can be compared to surfaces obtained in grinding processes. Hence, it can be assumed that CWR technologies can be successfully employed in manufacturing aluminum alloy products with minimal machining allowances.

During the experimental tests for the CWR process of forgings made from aluminum alloys, the process force parameters were also analyzed, as information about them is vital as far as devising technological processes is concerned. Correct determining of force values allows for employing a rolling mill which will be appropriate for the process, while information about force distributions allows for predicting phenomena which will hinder obtaining proper products. Figure 4 presents some examples of force distributions depending on the tool movement, which were observed during the CWR process of forgings made from alloy 6101A with the tools of forming angle $\alpha = 25^\circ$, at the deformation ratio Δr changing every 2 mm.

In the initial phase of the process, after the billet location was calculated by wedge segments, the force rises abruptly. In this phase the tools cut into the material, with the wedges gradually sinking into the product being formed at the depth Δr , thereby reducing its diameter to the required value d . A sudden increase in the force value occurs when cross-section reduction gets extended from the center towards the frontal surfaces of the product, over the necessary rolling length. After the abrupt increase resulting from extending of the deformation area to the whole length of the product, the force stabilizes

and reaches a relatively constant level. Next, with the beginning of the sizing phase, the forming force begins to decrease quite rapidly and reaches the zero value.

It is more difficult to employ CWR processes in forming titanium alloy forgings owing to a high resistance to metal flow. This very often disrupts the process stability and leads to product distortion in rolling conducted at higher deformation ratios. Figure 5 presents some examples of elementary shaft forgings made from titanium alloy Ti6Al4V.

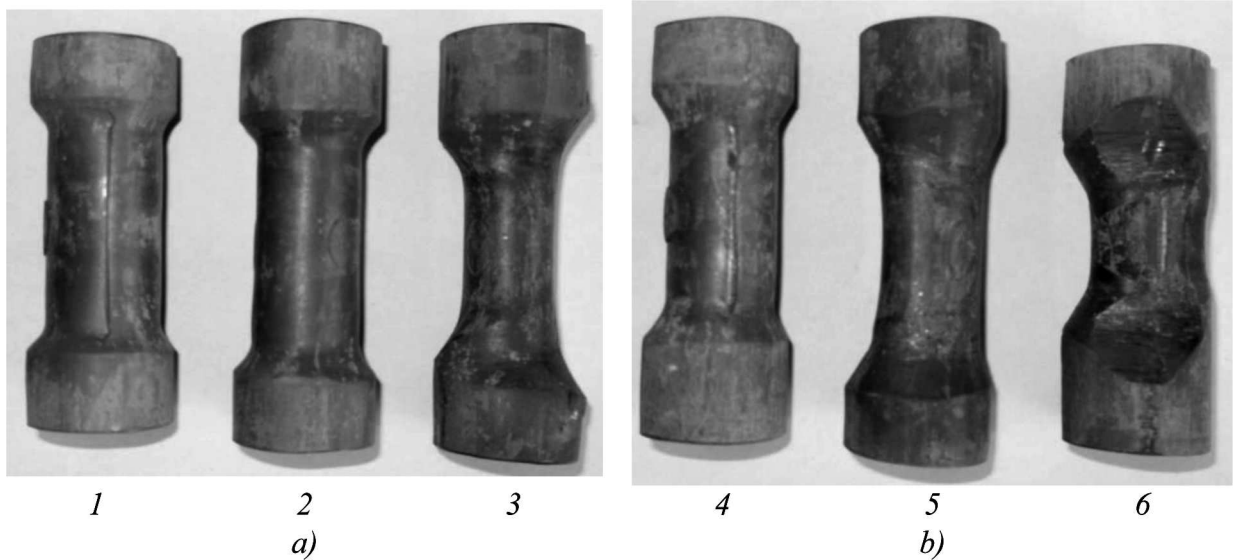

Fig. 5. Forgings made from titanium alloy Ti6Al4V rolled in the CWR process with segments at the following parameters: at wedge spreading angle $\beta = 5^\circ$ and at different forming angle values: a) $\alpha = 40^\circ$, b) $\alpha = 32.5^\circ$, at different deformation ratio values: 1 - $\delta = 1.36$, 2, 4 - $\delta = 1.5$, 3, 5 - $\delta = 1.67$, 6 - $\delta = 1.87$

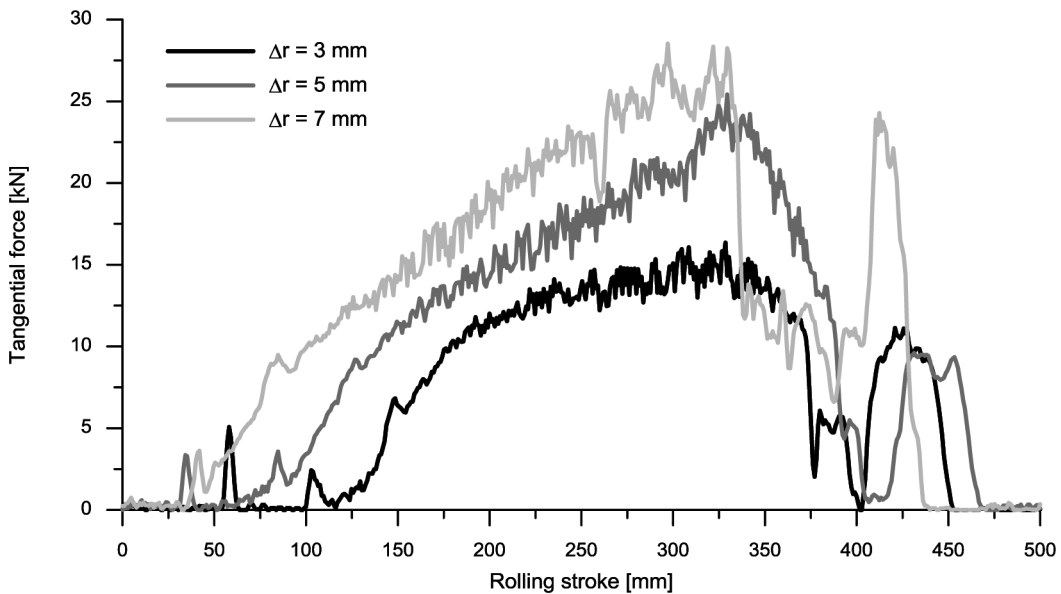

Fig. 6. Distributions of forming forces observed in the CWR process of forgings made from titanium alloy type Ti6Al4V, conducted at different values of the deformation ratio δ , the other parameters being: $\alpha = 25^\circ$, $\beta = 5^\circ$, $T = 960^\circ C$, $v = 0.125$ m/s

The cross wedge rolling process of titanium alloys involves a much higher resistance of metal plastic flow. It is proven by discrepancies occurring between shape and measurements of the rolled steps when compared to the ones which had been assumed before the tests were conducted. The cross section dimensions of properly formed forgings are much bigger than the assumed ones. The observed deviations range from +0.8 mm to +1 mm. Cross section ovalisation of the rolled step was also observed and its occurrence may result from the fact that the sizing part of the tool was too short. The observed defects are also caused by insufficient rigidity of the employed rolling mill, whose frame undergoes elastic distortions under the rolling forces. One of the limitations on the CWR process of forgings made from titanium alloys is uncontrolled slipping, which occurs when shafts whose deformation ratios were higher than $\delta > 1.5$ are rolled. The uncontrollable slipping distorts the proper course of the process and leads to deviation and damaging of the product (Fig. 5a3 and b6). The surface quality of the forgings formed at deformation values ranging from $\delta = 1.25 \div 1.5$ is relatively high. No defects such as breaking, tearing, or lapping were observed here. It is therefore conceivable that products formed at such deformation ratios on rolling mills with rigid constructions will be characterized by high accuracy and quality.

An example distribution of forming forces observed during the CWR process of forgings made from titanium alloys is illustrated in Fig. 6. One common characteristic of the shown distributions is a gradual force increase at the beginning of the forming process which occurs when the tools cut into the metal. The rolling forces reach their maximal values on the border between the forming and sizing zones, and then they suddenly drop to reach the zero value (in the sizing zone). However, a different force distribution was observed with the forging rolled at a relatively high deformation value $\Delta r = 7$ mm. A sudden decrease in the force value observed in the forming zone results from uncontrolled slipping as the defects of the obtained forging prove. Force distributions observed in rolling at lower deformation values ($\Delta r = 3$ mm and $\Delta r = 5$ mm) show that the process runs in a stable manner.

Figure 7 presents examples of elementary shaft forgings made from magnesium alloys AZ31, AZ61, and Mg4AlZnMn, formed in CWR with flat wedge tools shown in Figure 2.

The rolling tests for magnesium alloys conducted with conventional wedge tools have shown a series of factors which disturb the process stability, as a result

of which proper products cannot be obtained. The main phenomenon which impedes CWR processes of magnesium alloys is uncontrolled slipping, which occurs already at relatively low deformation ratios and causes product deformity (Fig. 7b). Uncontrolled slipping which disturbs the stability of the rolling process results from relatively low plasticity of magnesium alloys, which renders obtaining more significant plastic deformations difficult.

The cross wedge rolling process of magnesium alloys is feasible to conduct only at low deformation ratios, whose value cannot exceed $\delta \leq 1.36$. This, however, has impact on the value of maximum cross section reduction obtained in one working cycle, which is very low and does not exceed $R_p \leq 46$ %. Higher deformation values obtained in the CWR process of magnesium alloys could probably be obtained by introducing changes into tool geometry and decreasing the spreading angle value. Yet, such change results in elongation of wedge segments as well as it makes the forming time longer, which renders the forming process difficult due to over-cooling of the billet. Properly formed forgings with low deformation ratios (Fig. 7a) have a highly accurate and smooth surface. The observed defects, such as indentations or small distortions, result from an inappropriate state of the working tool surface.

Examples of force distributions observed during rolling tests for an elementary shaft forging made from three magnesium alloy types (AZ31, AZ61, and Mg4AlZnMn), whose deformation values $\delta = 1.36$, are presented in Fig. 8. The illustrated distributions are similar to the ones observed in rolling of aluminum alloys. In the initial phase of the process, the force increases quite rapidly as the tools cut into the metal to reach its maximum value on the border between the forming and sizing zones (see the distributions for alloys AZ31 and AZ61). Then, the force maintains a relatively constant level, which coincides with the moment when the forging step is being formed by the lateral surfaces of the tool. After surface irregularities have been removed from the rolled product in the sizing zone, the force value abruptly drops to zero. In contrast, the force distribution determined for alloy Mg4AlZnMn is different. In this case, a sudden increase in the tangential force in the cutting zone is to be observed; the force then quickly decreases only to fluctuate afterwards. This happens when the process stability is disturbed owing to uncontrolled slipping, which leads to the tearing off of the material outer layers and causes a considerable product deformity (Fig. 7b).

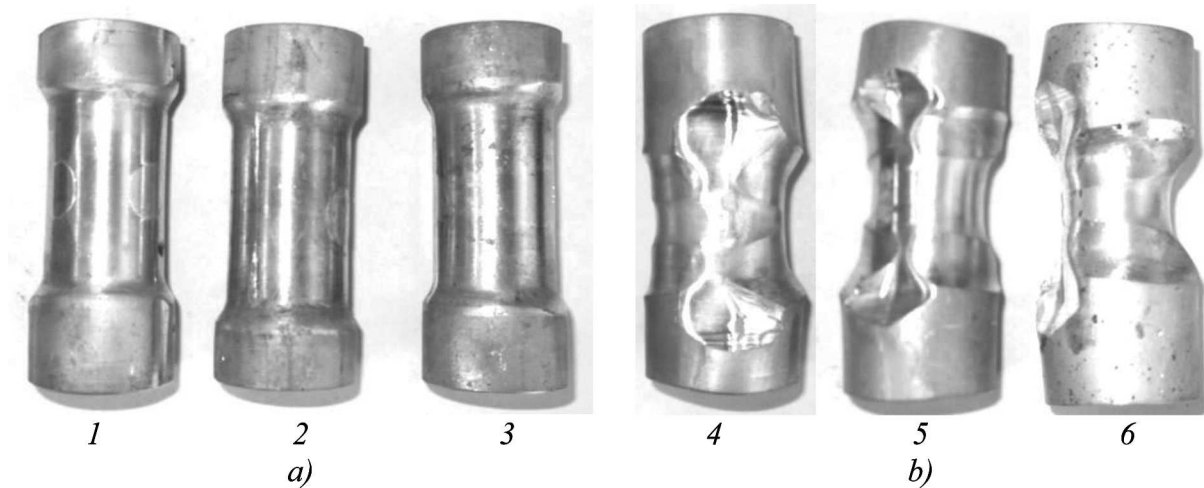

Fig. 7. Elementary shaft forgings made from magnesium alloys obtained in the CWR process conducted at the following parameters: a) $\alpha = 32.5^\circ, \beta = 5^\circ, \delta = 1.25$: 1 – Mg4AlZnMn, 2 – AZ31, 3 – AZ61, and b) $\alpha = 32.5^\circ, \beta = 5^\circ, \delta = 1.67$: 1 – Mg4AlZnMn, 2 – AZ31, 3 – AZ61

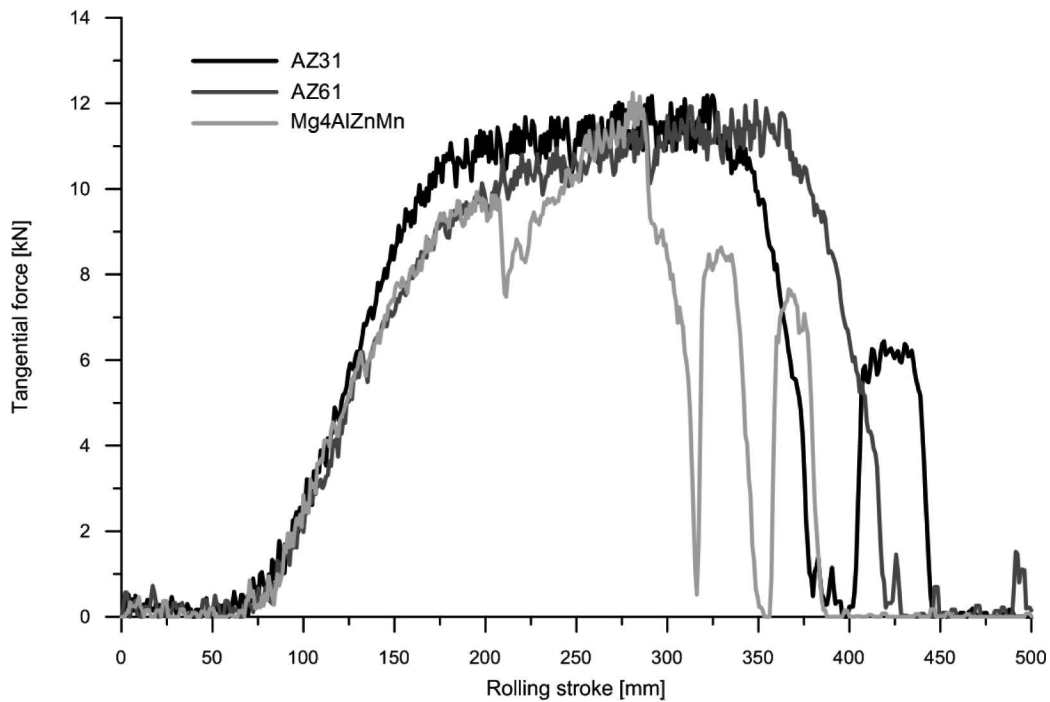

Fig. 8. Forming force distributions observed in the CWR process of forgings made from magnesium alloys conducted at the following parameters: $\alpha = 25^\circ, \delta = 1, 36, \beta = 5^\circ, T = 400^\circ\text{C}, v = 0.125 \text{ m/s}$

4. Conclusions

The conducted experimental tests prove the feasibility of forming both preforms and finished axially symmetric products made from light metal alloys, particularly from magnesium, titanium, and aluminum alloys, with the cross wedge rolling (CWR) method. The research works into the rolling process of an elementary shaft made from aluminum alloys 6101A and 2618A,

titanium alloy Ti6Al4V, and magnesium alloys AZ31, AZ61 and Mg4AlZnMn provide interesting results.

The experimental test studied the course of the process in terms of its stability and phenomena limiting the application of the CWR method. Force parameters, the knowledge of which is vital from a technological point of view, were analyzed as well.

During the experimental tests for CWR of forgings made from aluminum alloys, practically no phenomena

disturbing the process stability were observed. Only in the case of alloy 6101A, which was formed at the highest deformation ratio value ($\delta = 1.875$), did necking in the middle part of the forging occur, which was not the case as for alloy 2618A. The obtained products are characterized by high accuracy and high surface quality. Such characteristics are extremely noticeable in the case of materials with higher strength properties (alloy 2618A). It can therefore be assumed that it is possible to use the CWR process to form finished products or products with minimal machining allowances. On the other hand, due to screw grooves occurring on the surface of the formed step, forgings rolled from the more plastic alloy (6101A) can be used as all kinds of preforms; and when used for forming finished products they require that more machining allowance be left.

On the basis of the conducted experimental tests for CWR of forgings made from titanium alloy Ti6Al4V, it can be claimed that the CWR process can also be used in forming preforms and finished axially symmetric products. Both quality and accuracy of obtained products directly depend on such parameters as deformation ratio, the geometry of tool segments, tool rigidity as well as tool and machine construction. These factors guarantee to a great extent the rolling process stability. The experimental tests also analyzed force parameters of the CWR process, the knowledge of which is vital from a technological point of view, as it allows for an appropriate choice as far as engine size is concerned as well as it helps predict the occurrence of interferences which disturb the process stability and hence cause a change in the forming force distribution.

Equally vital data were obtained in the CWR process for forgings made from magnesium alloys (AZ31, AZ61, Mg4AlZnMn). It was observed that the cross wedge rolling process of forgings made from these materials is very difficult to conduct. Forming of magnesium alloys with CWR methods by means of conventional flat-wedge tools is possible only at low values of the deformation ratio δ . At higher deformation ratio values, the process stability is disturbed by uncontrollable slipping, which leads to product deformation.

The obtained test results may be considered valuable for both national and international industries. The application of CWR technologies to manufacturing elements made from light metal alloys, for example preforms meant for further forging operations or finished forgings, will significantly decrease the use of both expensive materials and energy, as well as of labor demand. The observed limitations prove the necessity of conducting further research works in the field of the CWR process for such materials.

Acknowledgements

Financial support of Structural Funds in the Operational Programme – Innovative Economy (IE OP) financed from the European Regional Development Fund – Project "Modern material technologies in aerospace industry", Nr POIG.01.01.02-00-015/08-00 is gratefully acknowledged.

REFERENCES

- [1] T. R z y c h o ń, J. S z a l a, A. K i e ł b u s, Microstructure, castability, microstructural stability and mechanical properties of ZRE1 magnesium alloy. Archives of Metallurgy and Materials **57**, 252-254 (2012).
- [2] Z. P a t e r, Walcowanie poprzeczno-klinowe. Wydawnictwo Politechniki Lubelskiej, Lublin 2009.
- [3] Z. P a t e r, W. W e r o ń s k i, Podstawy procesu walcowania poprzeczno-klinowego. Wydawnictwo Politechniki Lubelskiej, Lublin 1996.
- [4] Z. P a t e r, A. G o n t a r z, W.S. W e r o ń s k i, Wybrane zagadnienia z teorii i technologii walcowania poprzeczno-klinowego, Lubelskie Towarzystwo Naukowe, Lublin 2001.
- [5] X.P. F u, T.A. D e a n, Past developments, current applications and trends in the cross wedge rolling process. International Journal of Machinery Tools Manufacture Design, Research and Application **33**, 367-400 (1993).
- [6] V.A. K l u š i n, E.M. M a k u š o k, V.Ja. Š č u k i n, Soveršenstvovanie poperečno-klinovoj prokatki. Minsk: Nauka i Technika 1980.
- [7] Transverse rolling proves its uses in components field. The Engineer 55-58, 5 November 1970.
- [8] M.T. W a n g, X.T. L i, F.S. D u, Current trends in cross wedge rolling for part forming. ISIJ International **45**, 1521-1525 (2005).
- [9] K. B e l m o n t, Commercial wedge rolling in the United States. W: Proceedings of 2nd International Conference on Rotary Metalworking Processes October 6th – 8th 1982, Stratford upon Avon UK, 385-397.
- [10] Developments in rotary metalworking. Machinery and Production Engineering 2 February 1983 s. 34-35.
- [11] Z. P a t e r, A. G o n t a r z, W. W e r o ń s k i, Analiza możliwości zastosowania walcowania poprzeczno-klinowego do wytwarzania korpusów noży obrotowych. W: Badania teoretyczno-technologiczne procesów plastycznego kształtowania metali. Lublin: Wyd. Politechniki Lubelskiej 2004, 13-41.
- [12] A. G o n t a r z, K. Ł u k a s i k, Z. P a t e r, W.S. W e r o ń s k i, Technologia kształtowania i modelowanie nowego procesu wytwarzania wkrętów kolejowych, Lublin: Wyd. Politechniki Lubelskiej 2003.
- [13] L.A. D o b r z a ń s k i, Metalowe materiały inżynierskie. Wydawnictwo Naukowo-Techniczne, Warszawa 2004.
- [14] A. G o n t a r z, A. D z i u b i ń s k a, Własności stopu magnezu MA2 (wg GOST) w warunkach kształtowania na gorąco. Rudy i Metale Nieżelazne **6**, 340-345 (2010).

- [15] A. Gontarz, A. Dziubińska, Ł. Okoń, Determination of friction coefficients at elevated temperatures for some Al, Mg and Ti alloys. *Archives of Metallurgy and Materials* **56**, 379-384 (2011).
- [16] Y. Oishi, N. Kawabe, A. Hoshima, Y. Okazaki, A. Kishimoto, Development of High Strength Magnesium Alloy Wire. *Sei Technical Review* **56**, 57 (June 2003).

Received: 20 February 2012.