

## THE METHODOLOGY OF ANALYSIS ON GEOMETRICAL CHANGES OF A MIXED ZONE IN RESISTANCE-HEATED SAMPLES

The article presents the use of computer graphics methods and computational geometry for the analysis on changes of geometrical parameters for a mixed zone in resistance-heated samples. To perform the physical simulation series of resistance heating process, the Gleeble 3800 physical simulator, located in the Institute for Ferrous Metallurgy in Gliwice, was used. The paper presents a description of the test stand and the method for performing the experiment. The numerical model is based on the Fourier-Kirchoff differential equation for unsteady heat flow with an internal volumetric heat source. In the case of direct heating of the sample, geometrical parameters of the remelting zone change rapidly. The described methodology of using shape descriptors to characterise the studied zone during the process allows to parametrise the heat influence zones. The shape descriptors were used for the chosen for characteristic timing steps of the simulation, which allowed the authors to describe the changes of the studied parameters as a function of temperature. Additionally, to determine the impact of external factors, the remelting zone parameters were estimated for two types of grips holding the sample, so-called hot grips of a shorter contact area with the sample, and so-called cold grips. Based on the collected data, conclusions were drawn on the impact of the process parameters on the localisation and shape of the mushy zone.

*Keywords:* mixed zone, resistance heating, computer simulation, visualization, computational geometry

### 1. Introduction

Mechanical parameters of the final product depend on the chemical content of the material, its production process and the final thermal treatment. Since it is essential to introduce energy-saving methods, the method of constant steel casting has become very popular. Due to its specific way of metal solidification, it is a process which creates a lot of technological problems. The parameters of the material depend on its cooling time and band deformation in the mixed (liquid-solid) zone, which further influences elemental segregation and crystalline structure. The topical study for commercial usage is also performed for other metals [1]. Since determination of mechanical parameters in extremely high temperatures is difficult due to technological issues, the process has to be supported with computer simulation. The determined mechanical properties, aided by a proper mathematical model, may be used to simulate the rolling with a semi-solid zone. In the case of steel, minor changes of the temperature range 'solidus – liquidus' result in dramatic changes of mechanical properties, which causes huge optimisation problems and enforces consideration of numerous complicated phenomena. As a result, the computational model becomes very complicated, uses a lot of computer resources and the computational time becomes very long. To analyse the obtained results, the more

and more frequently used computer graphics and computational geometry methods may be implemented [2]. The key problem for the above mentioned process is parametrical description of the mixed zone where its geometry and location are essential. It is especially significant in the case of production where an error may lead to faults. One of the sciences related to the description of 3D objects is stereology. Stereological measurements may be performed on 2D sections of 3D structures [3,4]. The measurement based on the elements of the image allows to determine the parameters which classify the objects to a particular group [5]. The research relied on Jarvis' convex hull algorithm to separate the area (nods) of the mixed zone, as well as the shape descriptors to parametrise the sample. The knowledge of the changes in the mixed zone during the technological process is very important for quick actions, hence a series of computation for chosen timing steps has been done. Within the research, a new program for complex simulation of constant steel casting is being created. To verify the model, it is necessary to collect the data on the mixed zone occurring in the pounding area of the strand. Direct examination of the zone due to technological conditions is not possible, which is why a down-scaled simulation on physical simulators is used. It enables to monitor the parameters in measuring points. The researched model allows to determine the parameters of the sample in its whole volume. Based on the obtained information,

\* AGH UNIVERSITY OF SCIENCE AND TECHNOLOGY, FACULTY OF METALS ENGINEERING AND INDUSTRIAL COMPUTER SCIENCE, AL. MICKIEWICZA 30, 30-059, KRAKÓW, POLAND

\*\* THE JAN KOCHANOWSKI UNIVERSITY (JKU), DIVISION OF COMPUTER SCIENCE, 5 ŻEROMSKIEGO STR., 25-369 KIELCE, POLAND

# Corresponding author: debinski@agh.edu.pl

it is necessary to determine the temperature influence zones. The most important zone from the technological point of view is the mixed zone. The presented solution allows to identify the area of that zone occurrence as well as its shape. To make it possible to compare geometrical parameters of the zone it was necessary to determine the parameters describing it, i.e. so called shape descriptors. Thanks to it, it became possible to determine the influence of the process parameters on the parameters of the remelting zone, which in turn allows to verify the computation model. The article presents the elaboration on methodology of determining (and formal parametrical description) of the mixed zone geometry in steel samples.

## 2. Methodology of experimental tests

Physical experiments on the process of resistance heating were performed on the Gleeble 3800 simulator. For the first studied S355 steel, the characteristic solid and liquid temperatures were 1465°C and 1513°C respectively. The samples subjected to heating were circular in section of  $\phi 10$  mm and 125 mm long, and were mounted in the simulator system using the so-called hot grips of short contact zone with the specimen (Fig. 1a). For the second studied C45 steel, the characteristic solid and liquid

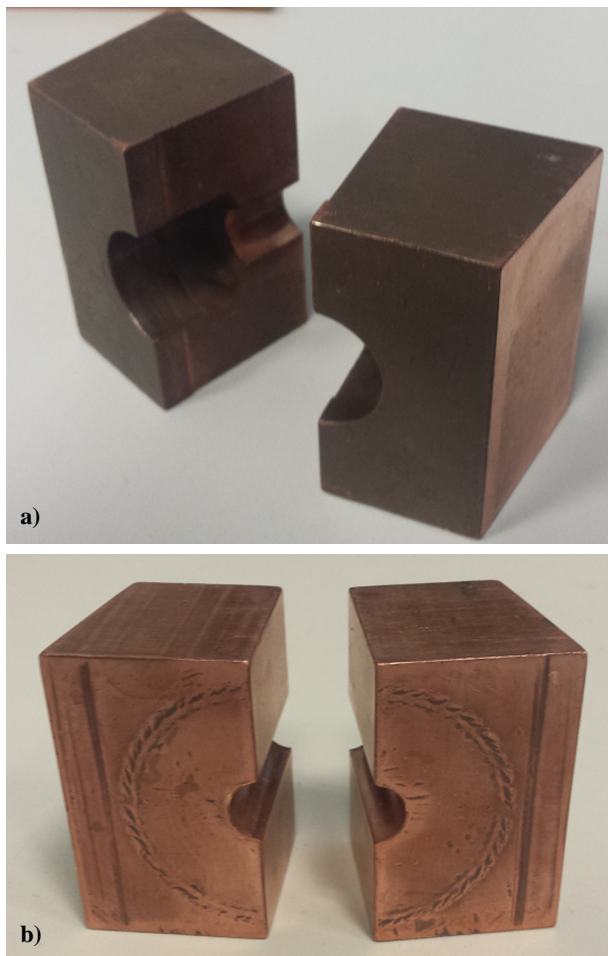

Fig. 1. The so-called hot grip (a) and cold grip (b) of the Gleeble 3800 simulator

temperatures were 1410°C and 1495°C respectively. In this case, the impact of the geometry of the tools on the temperature field was studied, the experiment was performed using two types of grips, so-called hot ones and so-called cold ones of longer contact zone with the sample (Fig. 1b).

Since the temperatures during the experiment oscillated within the melting temperature of the specimen, it was necessary to use quartz protection to prevent the interior of the simulator from any accidental leakage of the hot metal (Fig. 2).

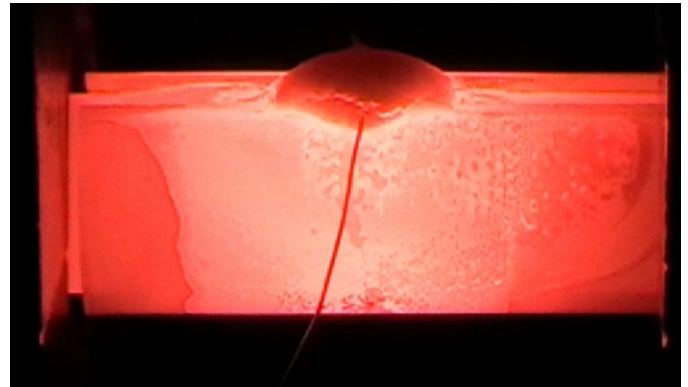

Fig. 2. A sample heated to the nominal temperature of 1425°C with the visible quartz protection and control thermocouple

Taking into consideration the characteristic solid and liquid temperatures of the researched steel, as well as the fact that in the case of resistance heating the highest temperatures are obtained along the axis of the sample, the first experiment (in order to determine the changes of mushy-zone parameters in the function of temperature) was performed according to the program relying on heating the sample up to 1400°C at the constant rate of 20°C/s, and then to 1450°C at the heating rate of 1°C/s. The specimen was then subjected to cooling at the controlled rate of 10°C/s down to the nominal temperature of 1200°C. Finally, the sample was freely cooled in the Gleeble 3800 grips down to the ambient temperature. The second experiment (to determine the change of mushy-zone parameters depending on the geometry of the tools) was performed according to the program relying on heating the sample up to 1350°C at the constant rate of 20°C/s, and then to 1430°C at the heating rate of 1°C/s. After 10 second resistance at the temperature of 1430°C it was cooled down to the temperature of 1380°C for the so-called cold grips, and to the temperature of 1400°C for the so-called hot grips. In both cases, the cooling was performed at the rate of 10°C/s. The specimen was then subjected to cooling at the controlled rate of 10°C/s down to the nominal temperature of 1200°C. During the experiment, such parameters as temperature, voltage and electric current were recorded.

## 3. Numerical model

The resistance heating process to obtain the assumed temperature inside the specimen and reach the remelting zone

was performed in the DEFFEM 3D simulation system [6]. The numerical model was based on the concept of unsteady thermal conductivity, taking into account internal volumetric source of heat. The temperature field in the cylindrical coordinate system for the isotropic case of axially-symmetric heat conductivity was determined from the dependence (1):

$$\lambda \left( \frac{\partial^2 T}{\partial r^2} + \frac{1}{r} \frac{\partial T}{\partial r} + \frac{\partial^2 T}{\partial z^2} \right) + Q = \rho c_p \frac{\partial T}{\partial \tau} \quad (1)$$

The values from the equation (1):  $Q$  – heat generation rate as a result of the electric current flow,  $\rho$  – sample density,  $c_p$  – specific heat presenting the thermal capacity at the temperature  $T$ ,  $\lambda$  – vector of the distribution function of heat conductivity coefficient,  $\tau$  – time. To precisely determine the temperature field it is essential to correctly choose the boundary conditions.

The model considered the usage of the special grips, the so-called hot grips, where the free heat exchange zone approximates at about 67 mm. For the heat exchange zones, 7 areas were defined ranging from  $A_0$  to  $A_6$  (Fig. 3). The areas defined as  $A_0$ ,  $A_6$  determine the contact area of the sample with mounting bolts. The areas  $A_1$  and  $A_5$  determine the contact area of the sample with the copper grips of the simulator. The areas  $A_2$  and  $A_4$  determine the free heat exchange zones with the ambient area. The last area  $A_3$  determines the contact area of the specimen with the quartz protection. Finally, the position of the numerical sensors of temperature was determined, which corresponded to the thermocouple sensors used in the real experiment – TC2, TC3 and TC4.

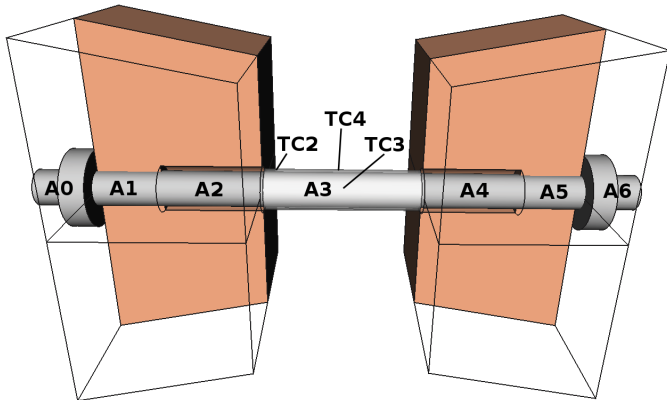

Fig. 3. The division scheme of heat exchange zones for the numerical model used with the “hot grip” along with the localisation of numerical temperature sensors

If the model considers the so-called cold grips, the length of the free heat exchange zone is about 30 mm. For the heat exchange zones, 5 areas from  $A_0$  to  $A_4$  were defined (Fig. 4). The zones  $A_0$ ,  $A_4$  are defined as the area of contact of the sample with the mounting bolts. The areas  $A_1$  and  $A_3$  determine the area of contact of the sample with the copper grips of the simulator. The zone  $A_2$  determines the area of contact of the sample with the quartz protection. The position of the numerical sensors of temperature is the same as that in the case of hot grips.

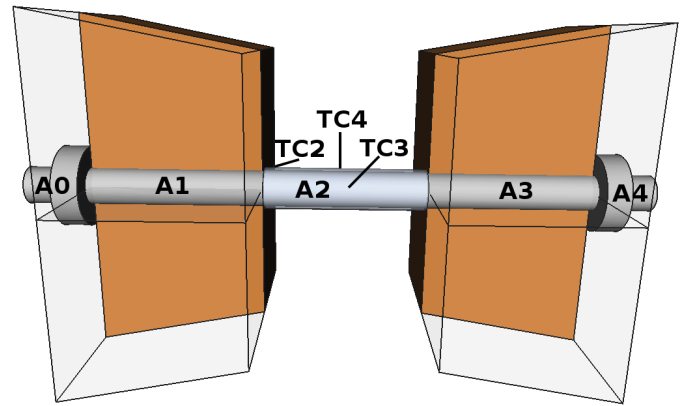

Fig. 4. The division scheme of heat exchange zones for the numerical model used with the “cold grip” along with the localisation of numerical temperature sensors

For each of the accepted heat exchange zones presented in Fig. 3 the boundary conditions were defined in the form of heat fluxes (equation 2):

$$q_i = \alpha_{eff}(t - t_i) \quad (2)$$

where:  $\alpha_{eff}$  defines substitute heat exchange coefficient for a given zone,  $t_i$  is the medium temperature in contact with a particular zone. Due to the fact that computations in consecutive timing steps depend on the results of the previous step, it is necessary to determine the initial condition from which the computation can be started. The condition was assumed to be the well-known temperature distribution (equation 3):

$$t(r) = t_0(r) \quad (3)$$

Boundary phenomena are frequently modelled using the heat exchange coefficient  $\alpha$ . Due to its value differentiation found in publications, the selection of a correct one poses a huge problem. A commonly used method of determining the value of the coefficient  $\alpha$  is to adjust the computation results to the values received in the course of the experiment. The presented solution assumed the following values: for the area of contact of the sample with the mounting bolts it was  $2000 \text{ W/m}^2\text{K}$ , for the area of the most intense heat exchange, the contact of the sample with the water-cooled copper grips it was  $5000 \text{ W/m}^2\text{K}$ , for the last two areas – free heat exchange with the ambient area and the contact area with the quartz protection – it was  $120 \text{ W/m}^2\text{K}$ .

A very important issue is the method of considering the generated heat as a result of the electric current flow. In the solution studied, the direct heating method was used. In contrast to the indirect method, this one is more difficult to implement both from the technical and numerical perspective. The phenomenon of heat production in the process of electric current flow through the sample was included in the equation 1 as the power of internal heat sources, which is proportional to resistance  $R$ , the current flow  $I$  squared and the intensity function  $A$  determined in the course of experiments (equation 4).

$$Q = A(\tau)[I^2(\tau)R(T)] \quad (4)$$

Due to the fact that in the real process resistance  $R$  and electric current intensity  $I$  depend on numerous parameters, especially temperature  $T$  and the heating time  $\tau$ , the conditions of heat conduction and the electric current change. It correlates to the change of resistance  $R$  in the model, which influences the efficiency of internal heat sources. An essential factor to correctly solve the problem of heat flow was the correct choice of dependencies describing the changes of thermo-physical properties of the studied material in the temperature function. The dependencies for the studied S355 steel on the basis of its chemical content were determined using the commercial JmatPro v.8 software.

#### 4. Methodology of determination and analysis of changes in geometrical parameters of the mushy zone

##### 4.1. Impact of the temperature on the evaluation of re-melting zone parameters

In order to facilitate the comparison of the parameters of the mixed zone received during the simulation it was necessary to elaborate methodology of determining its geometrical parameters. After setting the nodes of the FEM grid meeting the accepted temperature criterion for a particular material, it was necessary to determine parameters allowing to unequivocally characterise the zone shape. To describe the characteristic features of the studied area (shape) in computational geometry, descriptors [7] are used. This work also features such attitude, which allowed to estimate the changes of the area shape for chosen timing steps. The aim of this measurement was to reduce the shape of the element to a single size and the group of sizes characteristic for a given element. Since the result of the simulation was an approximated value of a real result, the determined characteristic sizes were an approximation of a real value. In the case of correct choice of measurement method, the characteristic values present compact data on the shape itself. To characterise the remelting zone, five chosen descriptors were used.

- **Circularity** (form factor) – describes degree of similarity of the described shape to the model, in this case – to the circle. It is the ratio of the surface area of the studied shape to the surface area of a circle of the same circumference as the studied shape, which is represented by the equation (5). The descriptor value approaches 1 for a circular shape.

$$\text{circularity} = \frac{S_i}{S_c} = \frac{S_i \cdot 4\pi}{P_i^2} \quad (5)$$

where:  $S_i$  – surface area of the studied element,  $S_c$  – surface area of the circle,  $P_i$  – circumference of the element.

- **Compactness of the object** – describes the so-called compactness of the element represented by the equation (6). The coefficient equals 1 for the most compact model, which is a circle.

$$\text{compactness} = \frac{2\sqrt{\frac{S_i}{\pi}}}{C_{\max}} \quad (6)$$

where:  $C_{\max}$  – the length of the longest chord of the studied element (the length of the segment joining two extreme points of the element).

- **Extensibility** (aspect ratio) determines the proportionality of the studied shape. The descriptor was presented with the equation (7).

$$\text{aspect ratio} = \frac{L_{\min}}{L_{\max}} \quad (7)$$

where:  $L_{\min}$  – the length of the minimum segment joining two border points of the figure, passing through its centre of gravity,  $L_{\max}$  – the length of the maximum segment joining two border points of the figure, passing through its centre of gravity.

- **Rectangularity** – determines the object's similarity to a rectangle. It is the ratio of the surface area of the shape to the surface area of a minimum rectangle surrounding a given shape (8).

$$\text{rectangularity} = \frac{S_i}{S_r} \quad (8)$$

where:  $S_r$  – surface area of a minimum rectangle surrounding the shape.

- **Volume of zone** represented as the ratio of the zone volume to the volume of the whole sample, expressed as percentage (9).

$$\text{volume} = \frac{V_i}{V_s} \cdot 100\% \quad (9)$$

where:  $V_i$  – volume of the mushy zone,  $V_s$  – volume of the sample.

For the axisymmetric case, it was possible to estimate the position of the zone as well as to determine the parameters describing its shape. In order to set the border nodes of the zone, Jarvis's computational geometry algorithm was used [8] to solve the convex hull problem. The method allowed to determine the border nodes of the remelting zone in the form of a convex polygon containing a cloud of nodes, whose temperature exceeded the solidus line for the studied material. Afterwards, based on it, a further analysis was performed using chosen descriptors of shape. Since the computation was performed for the axially-symmetric model, in order to visualise it was necessary to build a 3D model of a solid of revolution based on the flat model with given accuracy. To do so, the calculation of the coordinates of the nodes creating the solid in the polarized coordinate system was implemented. To determine the points in the Cartesian space it was necessary to transgress from the polarized system to the Cartesian one. For a given position vector, where  $r > 0$ ,

Numerical comparison data of the determined shape descriptors during the experiment of resistance heating for chosen values of the nominal temperature obtained

Temperature TC4 Descriptor	1420	1425	1430	1435	1440	1445	1450	1450
aspect ratio	0.5	0.5	0.601	0.649	0.671	0.75	0.8	0.8
circularity	0.635	0.809	0.838	0.839	0.884	0.910	0.919	0.917
rectangularity	0.51	0.666	0.710	0.727	0.846	0.877	0.75	0.791
compactness	0.569	0.690	0.782	0.774	0.838	0.849	0.797	0.808
% of max volume	0.085	0.148	0.596	1.706	2.645	3.361	5.461	6.143

and amplitude  $\varphi \in [0, 2\pi)$  of point  $P$ , its Cartesian coordinates were determined from the relation (10). The visualisation was performed using the OpenGL graphic library [9].

$$\begin{aligned} x &= r \cos(\varphi) \\ y &= r \sin(\varphi) \end{aligned} \tag{10}$$

The results presenting the temperature area were collected for chosen timing steps. Based on the characteristic temperatures of the studied steel, nodes of the temperature exceeding the solidus line were separated. For the cloud of points obtained in this way, in order to determine the outline of the area containing all the points found, Jarvis' convex hull algorithm was used. The obtained areas were described by determining the shape descriptors. Finally, 3D solids were created by the rotation of the section round its symmetry axis. In Table 1 were presented numerical comparison data of the values of the obtained descriptors. The results in the graphic form were presented in Fig. 5. For the particular timing steps, 3D visualisation of the solids of revolution was performed, which was presented in the Figs. 6-13.

Based on the changes of the parameters describing the geometry of the remelting zone it may be concluded that it is a process initially very unstable (with huge imbalances of the values of parameters) where, along with the increase of the temperature and the increase of the volume of the mushy zone, the

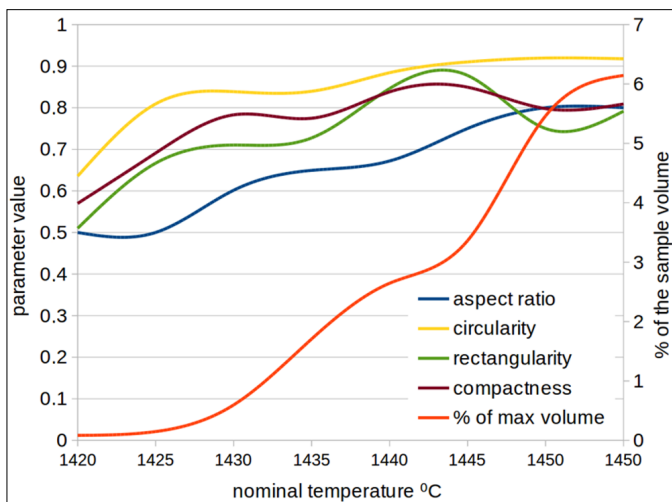

Fig. 5. Numerical comparison data of the determined shape descriptors during the experiment of resistance heating for chosen values of the nominal temperature obtained

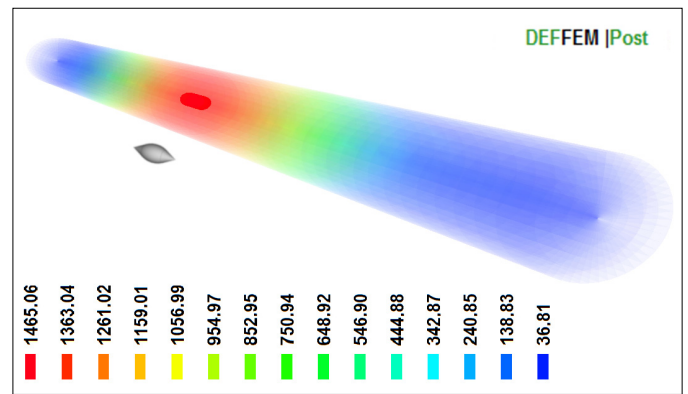

Fig. 6. Temperature area for a sample resistance heated to nominal temperature of 1420°C, along with the predicted shape of the mushy zone

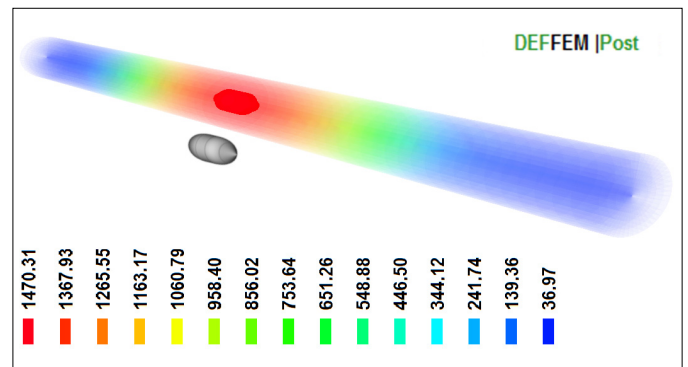

Fig. 7. Temperature area for a resistance heated sample to nominal temperature of 1425°C, along with the predicted shape of the mushy zone

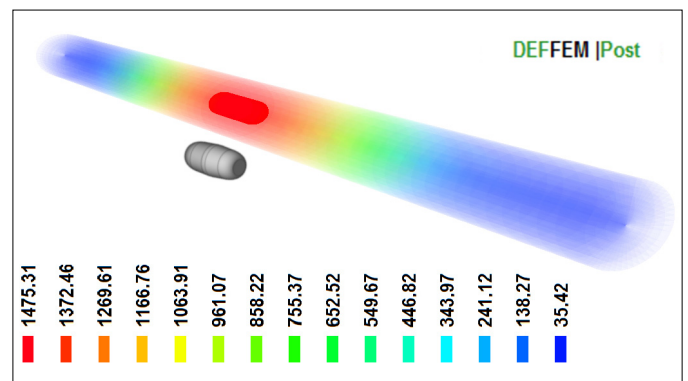

Fig. 8. Temperature area for a resistance heated sample to nominal temperature of 1430°C, along with the predicted shape of the mushy zone

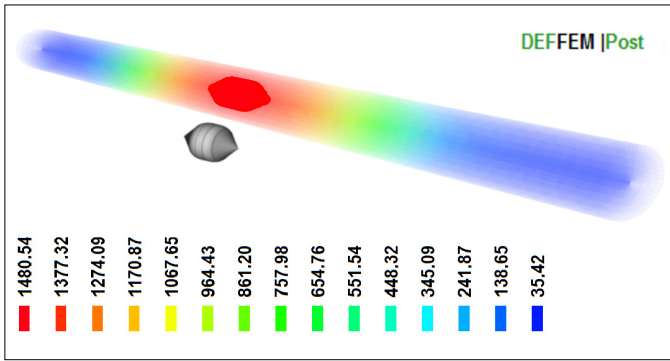

Fig. 9. Temperature area for a resistance heated sample to nominal temperature of 1435°C, along with the predicted shape of the mushy zone

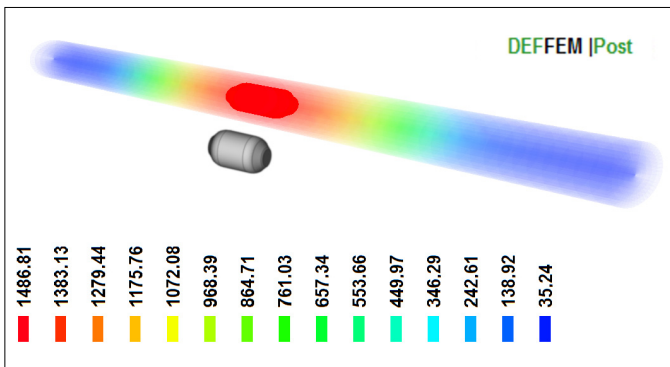

Fig. 10. Temperature area for a resistance heated sample to nominal temperature of 1440°C, along with the predicted shape of the mushy zone

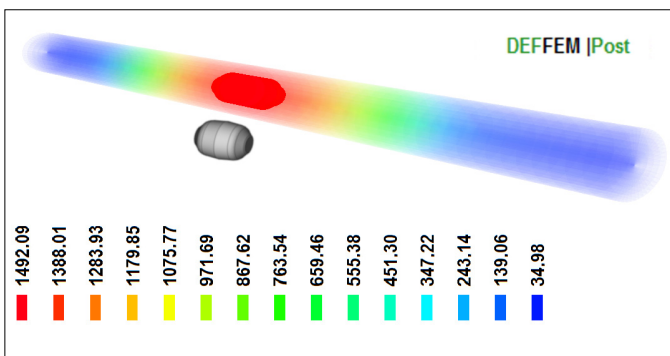

Fig. 11. Temperature area for a resistance heated sample to nominal temperature of 1445°C, along with the predicted shape of the mushy zone

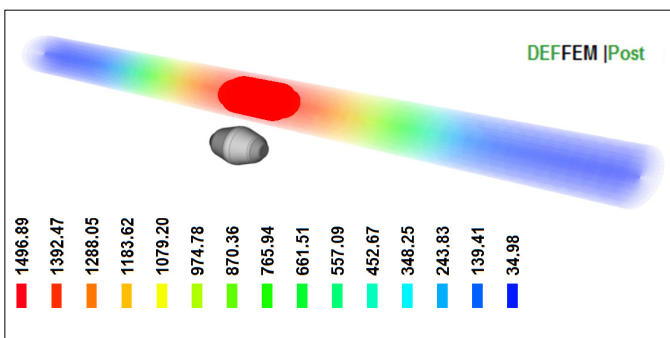

Fig. 12. Temperature area for a resistance heated sample to nominal temperature of 1450°C, along with the predicted shape of the mushy zone

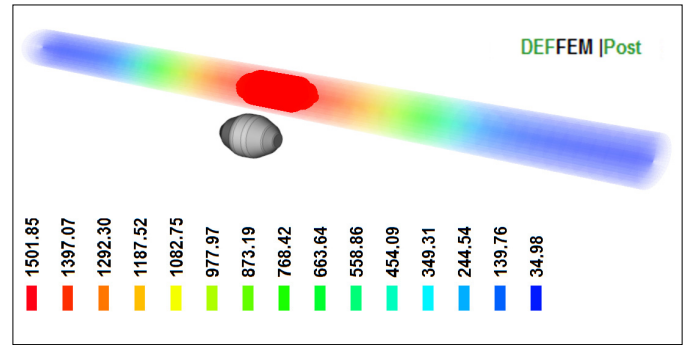

Fig. 13. Temperature area for a resistance heated sample to nominal temperature of 1455°C, along with the predicted shape of the mushy zone

parameters stabilise. The results present the case where anisotropy of the sample parameters was not taken into consideration. In real trials, the temperature spread is influenced by the material anisotropy and the change of electric resistance along with the temperature. The results are an initial estimation, which may give an overview of the changes of the parameters along with the increase of temperature. Based on the obtained results, an attempt to estimate the shape of the remelting zone was made.

#### 4.2. Impact of tool geometry on the evaluation of re-melting zone parameters

In order to study the influence of the geometry of the grips used to mount the samples in the Gleeble 3800 simulator on the calculation results, a simulation of resistance heating was performed using the so-called cold and hot grips. Table 2 presents the collation of the calculated values of chosen descriptors for two nominal temperatures 1380°C i 1400°C.

TABLE 2

Numerical comparison data of the determined shape descriptors during the experiment of resistance heating for two types of grips

Descriptor \ Temperature TC4	1380°C		1400°C	
	„cold grip”	„hot grip”	„cold grip”	„hot grip”
aspect ratio	0.714	0.674	0.575	0.500
circularity	0.836	0.891	0.851	0.843
rectangularity	0.938	0.917	0.812	0.813
compactness	0.837	0.841	0.771	0.719
% of max volume	0.622	2.638	0.978	11.092

Figure 14 presents the obtained results in the graphic form. The visualisation of the samples along with the temperature field and the predicted geometry of the remelting zone are presented in Figs. from 15 to 18.

The calculated values of the descriptors allow to determine a huge impact of the geometry of the tools on the parameters of the remelting zone. The usage of the so-called hot grips with a shorter contact zone with the sample causes the increase of the volume of the zone and its lengthening.

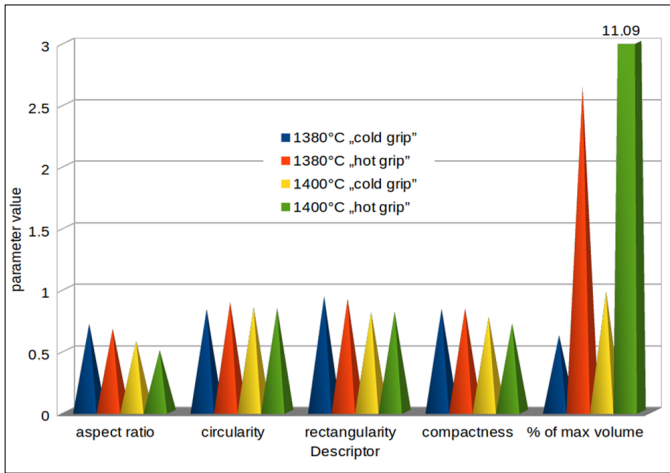

Fig. 14. Numerical comparison data of the determined shape descriptors during the experiment of resistance heating for two types of grips

### 5. Summary and conclusions

The development of computer graphics methods and the current possibilities of the graphic equipment allow the usage of numerous algorithms and solutions also in other areas. The article presented the usage of computational geometry method to identify characteristic nodes belonging to the remelting zone during the resistance heated simulation in the Gleeble 3800 simulator. The obtained results allowed to parametrically describe the geometry of the zone as well as its initial visualisation. A huge instability of parameters in the initial phase of remelting the sample was detected. Changes of parameters while increasing the volume of the remelting zone give evidence to the improvement of the proportionality of the zone shape. An analysis of the impact of the tools geometry used (simulator grips) on the geometry of the remelting zone was performed. The large influence in this case is the contact surface area of the sample grips. Due to the fact that the axially-symmetric model was used, in order to visualise the samples the polarised coordinate system was used, which allowed to set the points creating the sample solid in the 3D space. The obtained results may serve as a starting point for further research and more precise description of the zone as well as to specify the input parameters of the model. A possible implementation of the researched model and methodology of description of remelting zone shape is, for example, predicting failures where the border of liquid zone of the metal reaches the sample border (it may cause the loss of its consistency and leakage of the metal) even before performing a physical trial. Hence, there is a possibility to practically use the researched solution for further experimental research to eliminate the risk of erratic choice of parameters of the experiment and bearing extra costs. The next step to increase the precision of the description of the studied areas is to model the resistance heating process in the 3D space. It will be necessary to use solid descriptors for the obtained cloud of points.

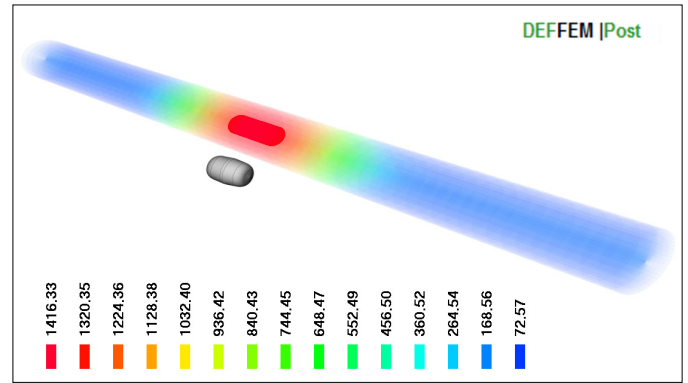

Fig. 15. Temperature area for a resistance heated sample to nominal temperature of 1380°C and “cold grips”

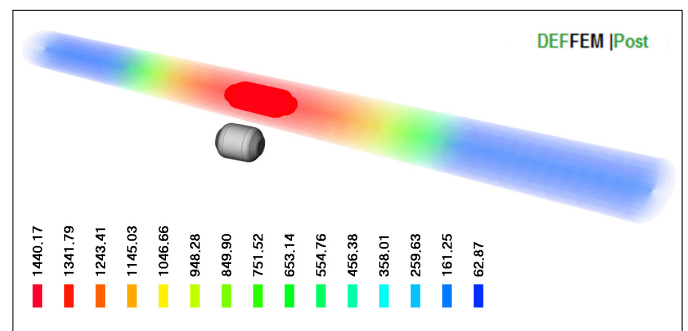

Fig. 16. Temperature area for a resistance heated sample to nominal temperature of 1380°C and “hot grips”

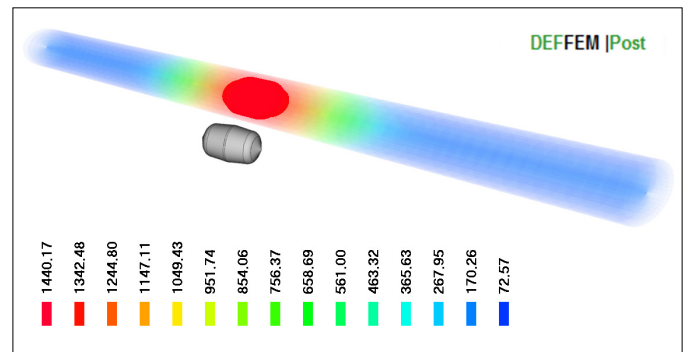

Fig. 17. Temperature area for a resistance heated sample to nominal temperature of 1400°C and “cold grips”

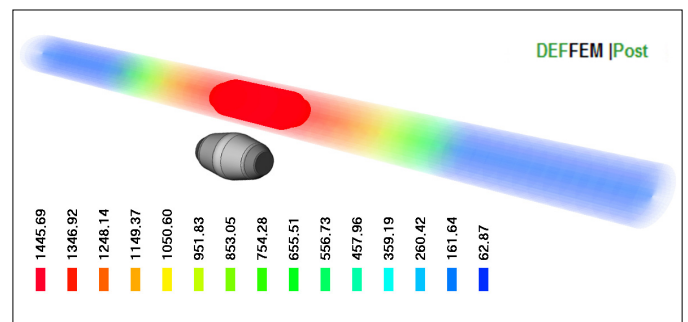

Fig. 18. Temperature area for a resistance heated sample to nominal temperature of 1400°C and “hot grips”

## ACKNOWLEDGMENT

1. The research work has been supported by the Polish National Science Centre, Decision number: DEC-2011/03/D/ST8/04041
2. Development of geometric methods for mushy-zone estimation supported by AGH grant no. 11.11.110.593

## REFERENCES

- [1] Stephen P. Midson, Industrial Applications for Aluminum Semi-Solid Castings, *Solid State Phenomena* **217-218**, 487-495 (2015).
- [2] T. Debinski, Estimation of localisation and geometric parameters for the semi-solid zone of steel samples. *Technical Transactions, Mechanics, Politechnika Krakowska*, 2018.
- [3] E.E. Underwood, *Quantitative Stereology*, Addison Wesley, Reading 1970.
- [4] J.C. Russ, *Practical Stereology*, Plenum Press, New York, 1986.
- [5] E. Stein, M. Bachmann, W. Heldens, A. Muller, Ch. Schmallius, A Spectral feature based classification algorithm for characterization of urban surfaces in Munich, 6th ERSeL SIG Image Spectroscopy Symposium, Tel-Aviv, 2009.
- [6] M. Hojny, Modeling of Steel Deformation in the Semi-Solid State, *Advanced Structured Materials* **47** Springer (2018).
- [7] Y. Mingqiang, K. Kidiyo, J. Ronsin, A Survey of Shape Feature Extraction Techniques, *Pattern Recognition*, PengYeng Yin (Ed.) 43-90 (2008)
- [8] F.P. Preparata, M.I. Shamos, *Computational Geometry. An Introduction*, Springer-Verlag New York Inc., 1985.
- [9] *OpenGL* (<http://www.opengl.org>), 2017-04-15.